



Product Catalog



CONTENTS

COMPANY OVERVIEW	3-9
Mission and Value	3
Research and Development	4
Materials and Production	5
Our Beliefs	6
Surface Treatment	7
Complete Implant Solutions	8
Connection Choices	9
IMPLANTS	10-16
ESi Implant	10-11
Premium Implant	12-13
Ultimate Implant	14-15
Solo One Piece Implant	16
PROSTHETICS	17-23
Titanium Healing Abutments	17
Zirconia Healing Abutments	17
Cover Screws	18
Implant Carrier	18
Impression Transfer	18
Cement-Retained Abutments	19-20
PEEK Temporary Abutments	20
Screw-Retained and Multi-Unit Restorations	21
Abutment Accessories and Prosthetics	21
Implant Prosthetic Indicator	22
Ball Attachments and Ball Attachment Covers	22
Screws and Accessories	23
INSTRUMENTATION	24-35
ESi / Premium Implants Surgical Tray	24
Ultimate Implant Surgical Tray	25
Mini ESi / Premium Implants Surgical Tray	26
Mini Ultimate Implant Surgical Tray	27
Implant Surgical Drills and Countersink	28-29
Drill Stoppers	30
Surgical Tools	31
Essentials Surgical Cassette	32
Periotome Extraction Cassette	33
Osteotome Sinus Lift Cassette	34
Torque	35

DENTAL KITS	36-45
Bone Expander Kit	36
Split Master Kit	37
Bone Chip Maker Kit	38
Fixture and Screw Removal Kit	39
Sinus Master Kit	40-41
CortiOss (Cortical Bone Powder / Chip)	42
CortiOss-D (Demineralized Cortical Bone Powder / Chip)	43
ConiOss (Cortical and Cancellous Bone Powder / Chip)	44
SpiralTech Motors and Hand-Held Drills	45
INDEX	46-50



COMPANY OVERVIEW

Our Company

Founded in 2012, SpiralTech was created to fill a void in the dental implant world—simplified treatment paired with the best technologies and customer service.

SpiralTech's goal is to provide doctors of all experience levels with innovative designed implants and accessories while providing all of the necessary educations and services.

Ultimately, our mission is to enhance the doctor-patient experience.

The ESI implant product line is the first step in what we see as a continuous journey towards clinical excellence.

Mission and Value

SpiralTech's mission is to manufacture advanced dental implant technology; paired with an industry-best customer service team; at affordable prices.

Our commitment to continuous research and development aims us to optimise the treatment process; allowing for state-of-the-art care to be shared and taught globally.



Research and Development

Enhancing the doctor-patient experience

Innovation is at the heart of SpiralTech. We focus on leading the industry with an engineering team that spans three continents who constantly strive to improve our processes, technology and systems—as well as developing the highest standards relating to best practices for patient treatment, and refining the doctor experience.

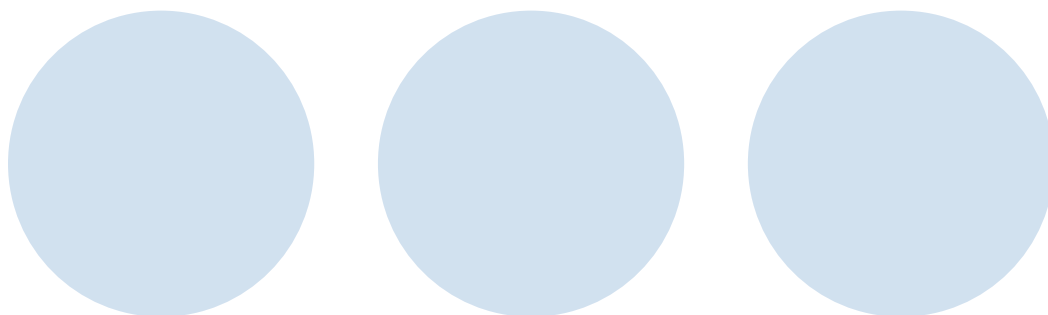

Simplicity

At SpiralTech, we believe contemporary implant therapy should be streamlined with the tools of intuitive design. We have developed advanced instruments that simplify the implant surgical process—a welcome change for novice and experienced surgeons. With features like drill sequences printed on the trays, universal depth stops and user-friendly packaging—SpiralTech implants saves time and helps maximize efficiency.

Materials and Production

Quality without Compromise

SpiralTech solutions are produced in world-class facilities with high-quality materials. Titanium-based solutions make use of a premium grade titanium alloy forged and surface treated in the United States; and our precision drilling systems are produced in Germany.

Key components from the United States, Italy and Germany are also integrated into SpiralTech implant solutions. All SpiralTech implant solutions are backed by a comprehensive 20-year warranty.



Quality Control

From milling to in-office delivery, SpiralTech's quality control systems and protocols ensure that only tested and verified products are shipped. At the time of milling; automated systems ensure exact dimensional standards are met. During surface treatment, only approved clean room environments are used and implants are micro-inspected.

From order placement to delivery, all purchases are tracked. They are then evaluated for accurate and timely delivery through our advanced supply chain systems.

After implant placement, SpiralTech provides case management for safety monitoring and for tracking long-term success.

At SpiralTech, we have a set of core beliefs

We pledge to all those involved with our work...

A continuous provision to our doctors and patients of the highest quality products, and always putting the long term health and safety of our patients above all else.

Constantly striving to provide an unrivaled level of customer service, innovation and progressive effort to move dental technology forward.

Not only do we further the reach of accessible, modern dental care globally—it is with devotion, time and resources that we dedicate ourselves to the educational advancement of dentists and surgeons.

Forever maintaining a leadership within the administrative and service teams to uphold the highest professional and ethical standards.

We go forth to affect, with maximum effort, all aspects of our company's operations to ensure long term success and support our employees in attaining dependable, worthwhile and personally-fulfilling careers.

And... we never stop asking, "How can we do better?"

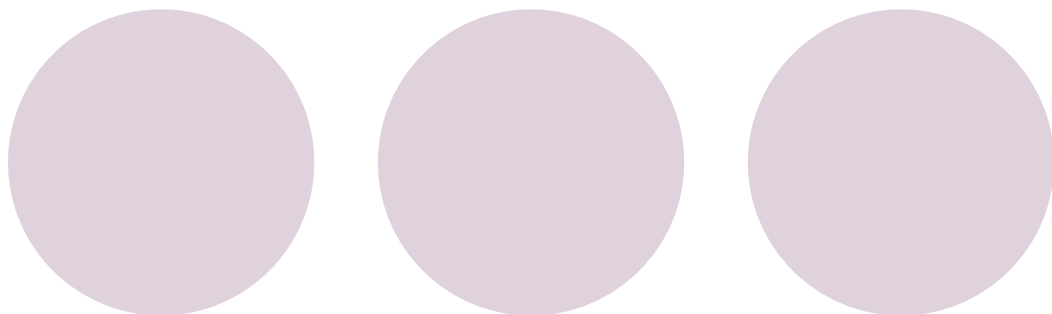

Two Proven Surfaces

SpiralTech implants all feature a proven SLA or RBM surface.

Applied in a controlled environment, the RBM process uniformly micro-roughens the implant to maximize surface area, bone cell growth and adhesion. Filler layers that could later form debris or compromise healing are omitted.

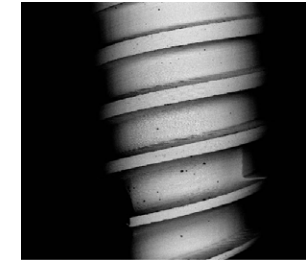
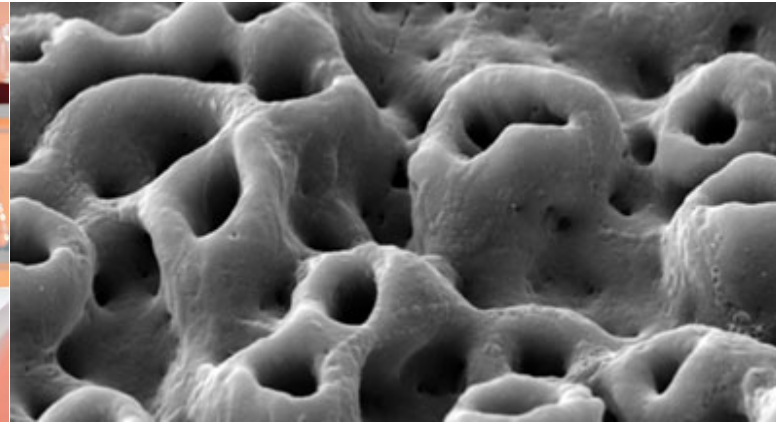

Implant after machining and washing is reasonably clean and mostly free from foreign particles, enabling good conditions for further stages of the surface treatment.



Implant shown after Alumina Blasting.

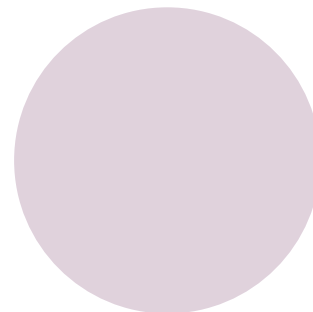
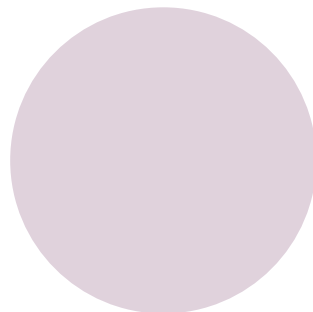
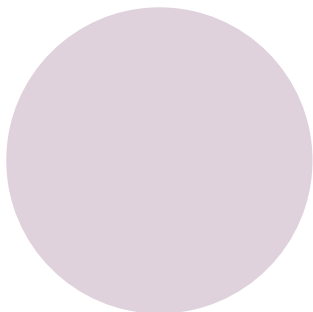



TM

Complete Implant Solutions

Three distinct implant body styles

There is a SpiralTech implant for every case. Whether bone level or tissue level, placed in sockets or placed in healed ridges, immediately loaded or covered healing, we have an implant that fits your needs.

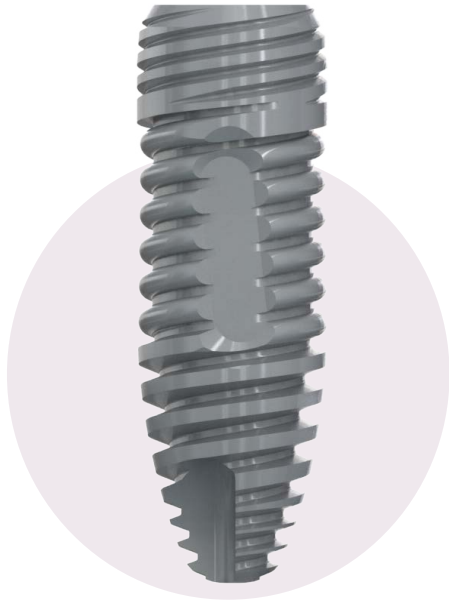

ESi

ESi is unlike any implant currently on the market. Its innovative design is doctor friendly, efficient and designed to ease your implant process.



Premium

Premium is a conventional implant that can be applied in soft and hard bone. Excellent for working in Type I & II bone.

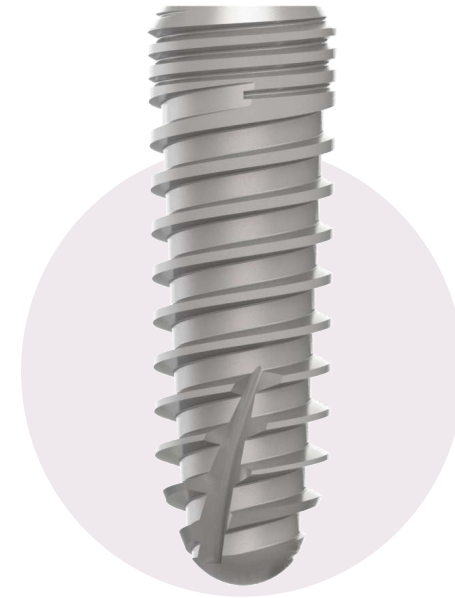

Ultimate

Our Ultimate implant can be used for immediate loading and is successful with stability and retention.

Three implants with Choice of Connection

Each implant comes with Hex or Conical Hex Connection

Both connections provide benefits of bone level platform switching.
Either connections are ideal for soft tissue maintenance and strong internal connections.

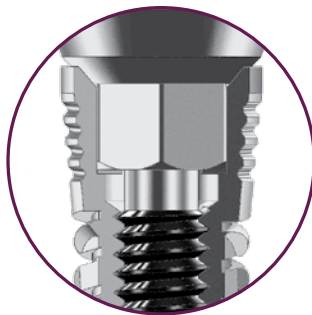

HEX CONNECTION

With many years of proven success; the hex connection is reliable and strong.



CONICAL HEX CONNECTION

The internal conical connection is increasingly popular due to its stability, precision fit and long-term strength.





TM

ESi™ Implant System

The Essential Spectrum Implant (ESi) has been patented.

The ESi implant is versatile and can be used in most clinical situations. Placement is intuitive and fast. Great for beginning and experienced surgeons alike.

All implants are provided with the corresponding cover screw and average-size healing abutment.

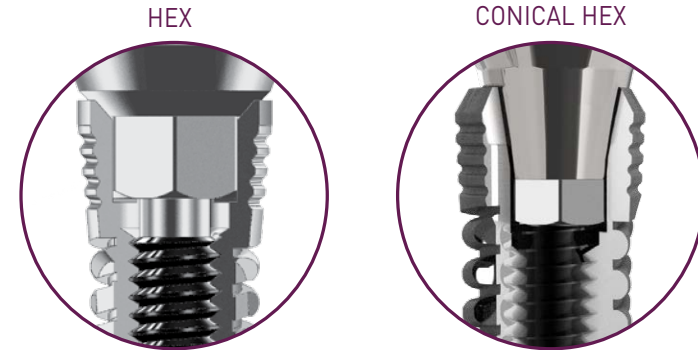

CONNECTIONS

Platform switching design

Crestal micro-grooves for enhanced bone maintenance

Self-tapping apical threads are knife-edged to improve implant penetration





Precision-fit internal connection, available in conical hex or hex

Rounded threads located in middle third reduce potential implant internal bone pressure





Stress-reduction fossa

ESi™ Implants *with Standard Hex or Conical Hex Connection*

Hex Connection

Diameter (mm)	Length (mm)	Catalog No.
	8.0	ESi35008
	10.0	ESi35010
	11.5	ESi35011
	13.0	ESi35013
	15.0	ESi35015
	6.0*	ESi43006
	8.0	ESi43008
	10.0	ESi43010
	11.5	ESi43011
	13.0	ESi43013
	15.0	ESi43015
	6.0*	ESi50006
	8.0	ESi50008
	10.0	ESi50010
	11.5	ESi50011
	13.0	ESi50013
	15.0	ESi50015
	6.0*	ESi60006
	8.0	ESi60008
	10.0	ESi60010
	11.5	ESi60011
	13.0	ESi60013
	15.0	ESi60015

Conical Hex Connection

Diameter (mm)	Length (mm)	Catalog No.
 NP	10.0	ESiC30010
	11.5	ESiC30011
	13.0	ESiC30013
	15.0	ESiC30015
	8.0	ESiC35008
 NP	10.0	ESiC35010
	11.5	ESiC35011
	13.0	ESiC35013
	15.0	ESiC35015
	6.0*	ESiC43006
 RP	8.0	ESiC43008
	10.0	ESiC43010
	11.5	ESiC43011
	13.0	ESiC43013
	15.0	ESiC43015
 RP	6.0*	ESiC50006
	8.0	ESiC50008
	10.0	ESiC50010
	11.5	ESiC50011
	13.0	ESiC50013
 RP	15.0	ESiC50015
	6.0*	ESiC60006
	8.0	ESiC60008
	10.0	ESiC60010
	11.5	ESiC60011
	13.0	ESiC60013
	15.0	ESiC60015

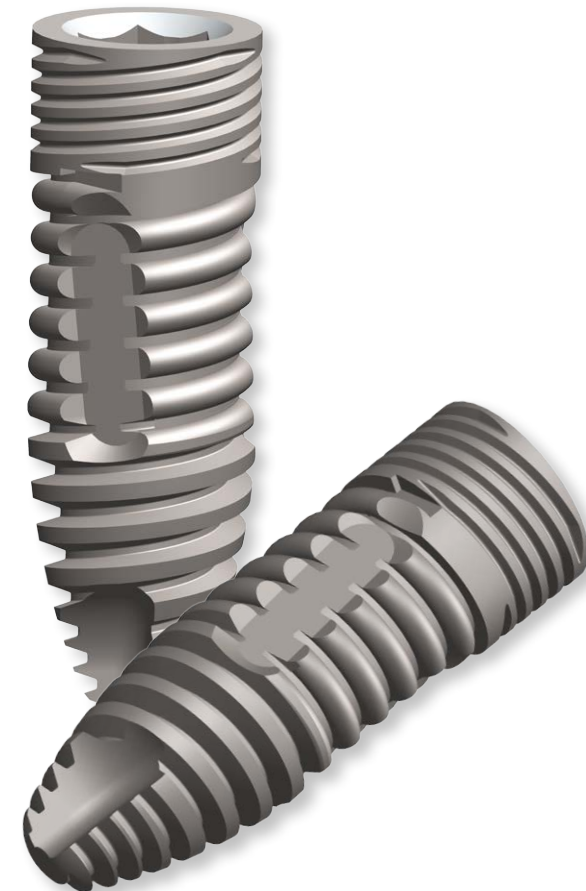

*Call for more information.



TM

Premium Implants

The Premium Implant is a conventionally designed implant. While it can be used in all clinical situations, its conservative threads are best suited for healed ridges.

All implants are provided with the corresponding cover screw.

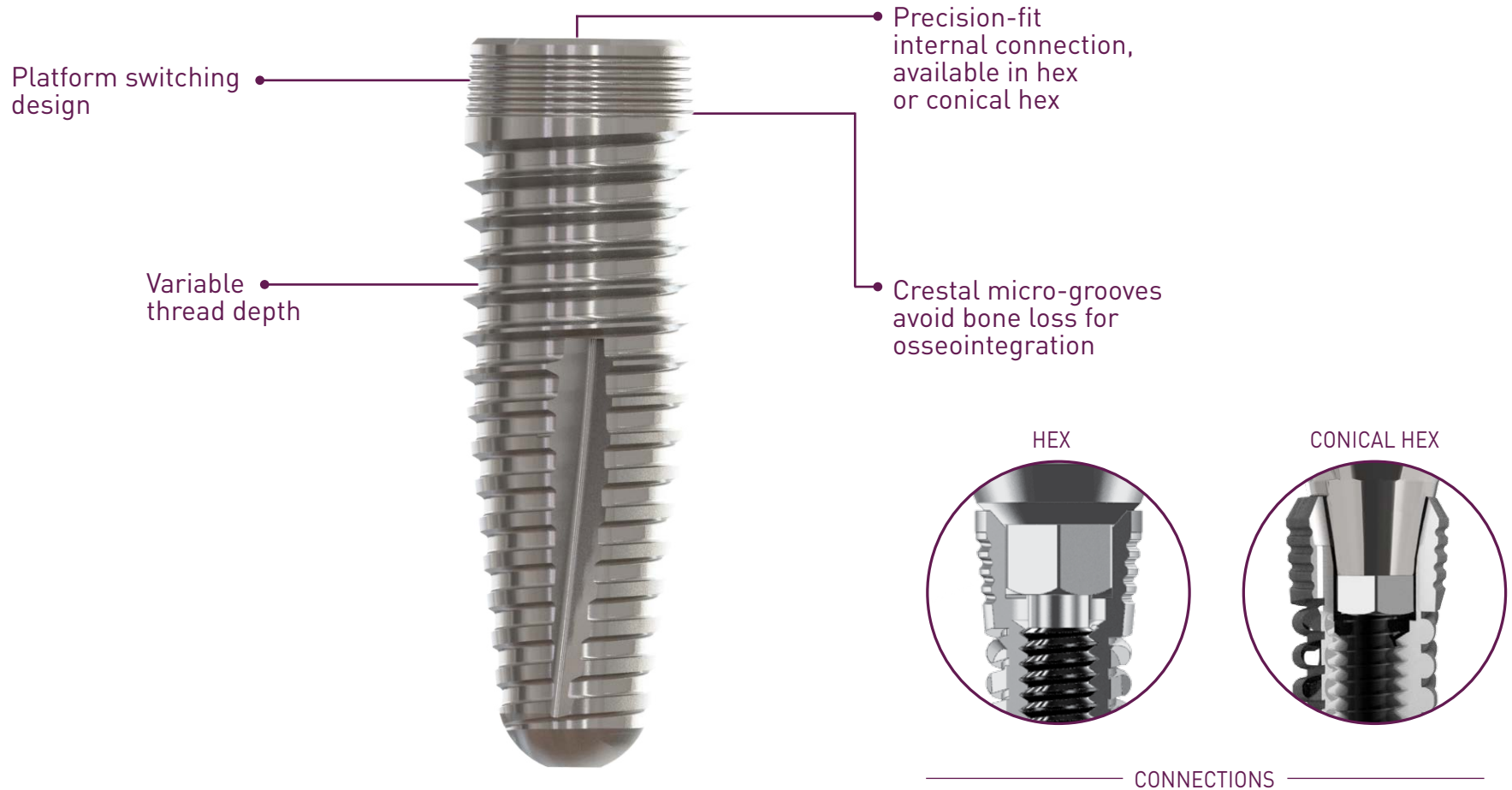

Premium Implants *with Standard Hex or Conical Hex Connection*

Hex Connection

Diameter (mm)	Length (mm)	Catalog No.
3.50	8.0	PR35008
	10.0	PR35010
	11.5	PR35011
	13.0	PR35013
	15.0	PR35015
4.30	6.0*	PR43006
	8.0	PR43008
	10.0	PR43010
	11.5	PR43011
	13.0	PR43013
5.00	6.0*	PR50006
	8.0	PR50008
	10.0	PR50010
	11.5	PR50011
	13.0	PR50013
6.00	6.0*	PR60006
	8.0	PR60008
	10.0	PR60010
	11.5	PR60011
	13.0	PR60013
	15.0	PR60015

Conical Hex Connection

Diameter (mm)	Length (mm)	Catalog No.
3.50 NP	8.0	PRC35008
	10.0	PRC35010
	11.5	PRC35011
	13.0	PRC35013
	15.0	PRC35015
4.30 RP	6.0*	PRC43006
	8.0	PRC43008
	10.0	PRC43010
	11.5	PRC43011
	13.0	PRC43013
5.00 RP	6.0*	PRC50006
	8.0	PRC50008
	10.0	PRC50010
	11.5	PRC50011
	13.0	PRC50013
6.00 RP	6.0*	PRC60006
	8.0	PRC60008
	10.0	PRC60010
	11.5	PRC60011
	13.0	PRC60013
	15.0	PRC60015



*Call for more information.



TM

Ultimate Implants

The Ultimate Implant is designed for initial stability, even in soft bone. It is a suitable implant for immediate placement and/or immediate loading. Due to its design, it can be slightly adjusted to reposition implant during the surgery.



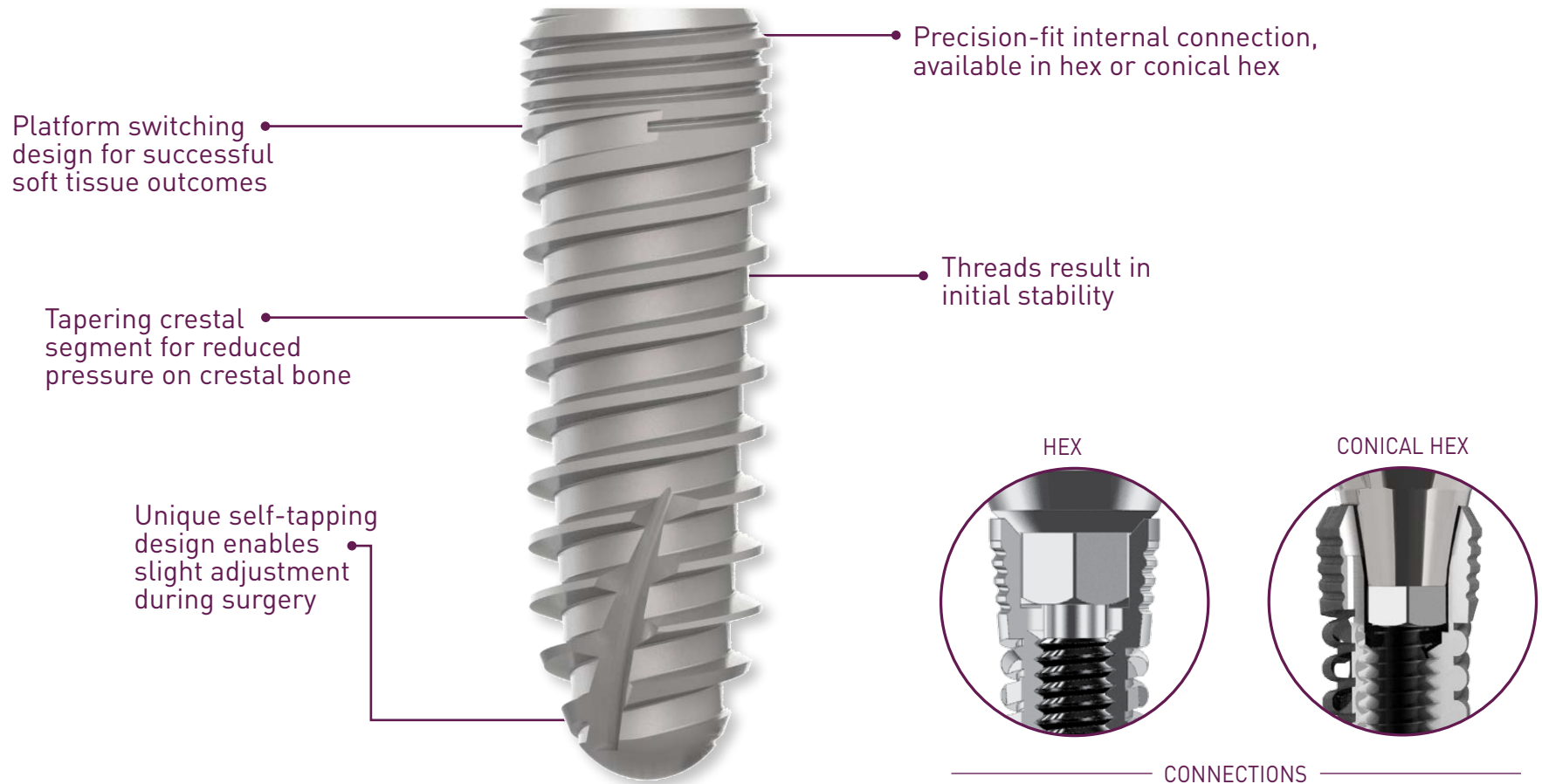

Suitable for type II, III and IV bone.

All implants are provided with the corresponding cover screw.







Ultimate Implants *with Standard Hex or Conical Hex Connection*

Hex Connection

Diameter (mm)	Length (mm)	Catalog No.
	8.0	UL35008
	10.0	UL35010
	11.5	UL35011
	13.0	UL35013
	15.0	UL35015
	6.0*	UL43006
	8.0	UL43008
	10.0	UL43010
	11.5	UL43011
	13.0	UL43013
	15.0	UL43015
	6.0*	UL50006
	8.0	UL50008
	10.0	UL50010
	11.5	UL50011
	13.0	UL50013
	6.0*	UL60006
	8.0	UL60008
	10.0	UL60010
	11.5	UL60011
	13.0	UL60013
	15.0	UL60015

Conical Hex Connection

Diameter (mm)	Length (mm)	Catalog No.
 NP	10.0	ULC30010
	11.5	ULC30011
	13.0	ULC30013
	15.0	ULC30015
 NP	8.0	ULC35008
	10.0	ULC35010
	11.5	ULC35011
	13.0	ULC35013
	15.0	ULC35015
 RP	6.0*	ULC43006
	8.0	ULC43008
	10.0	ULC43010
	11.5	ULC43011
	13.0	ULC43013
 RP	6.0*	ULC50006
	8.0	ULC50008
	10.0	ULC50010
	11.5	ULC50011
	13.0	ULC50013
 RP	6.0*	ULC60006
	8.0	ULC60008
	10.0	ULC60010
	11.5	ULC60011
	13.0	ULC60013
	15.0	ULC60015

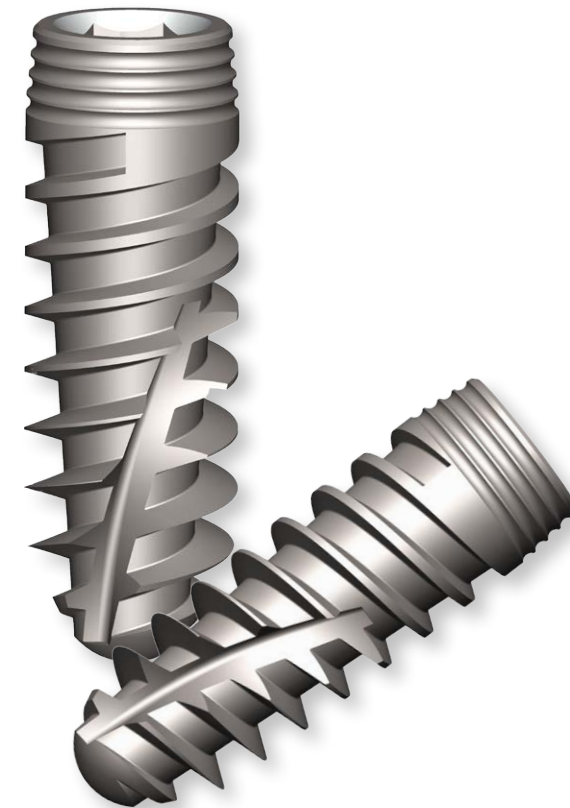

*Call for more information.

Solo One Piece

The Solo One Piece Implant is combined with an abutment. Spiraled, double, sharp and deep threaded implant.

*Call for more information.

Diameter	Length (mm)	Catalog No.
3.0mm	10.0mm	OP3010
	11.0mm	OP3011
	13.0mm	OP3013
	15.0mm	OP3015
3.3mm	10.0mm	OP3310
	11.0mm	OP3311
	13.0mm	OP3313
	15.0mm	OP3315
3.75mm	10.0mm	OP37510
	11.0mm	OP37511
	13.0mm	OP37513
	15.0mm	OP37515
4.2mm	10.0mm	OP4210
	11.0mm	OP4211
	13.0mm	OP4213
	15.0mm	OP4215



Titanium and Zirconia Healing Abutments

Available in various heights and diameters, healing abutments are used to sculpt soft tissues in preparation for placement of the final restoration. They can be used in a one-stage or two-stage surgical approach. All zirconia abutments have a 5mm height above the margin.*

Design	Diameter (mm)	Facial Height (mm)	Hex Catalog No.	NP Conical Catalog No.	RP Conical Catalog No.	Slim Conical Catalog No.
Titanium Healing Cap, Slim	3.5	2	-	-	-	HACSP352
		3	-	-	-	HACSP353
		4	-	-	-	HACSP354
		5	-	-	-	HACSP355
		6	-	-	-	HACSP356
Titanium Healing Cap, narrow	3.8	2	HAH382	HACNP382	HACRP382	-
		3	HAH383	HACNP383	HACRP383	-
		4	HAH384	HACNP384	HACRP384	-
		5	HAH385	HACNP385	HACRP385	-
		6	HAH386	HACNP386	HACRP386	-
Titanium Healing Cap, medium	4.5	2	HAH452	HACNP452	HACRP452	-
		3	HAH453	HACNP453	HACRP453	-
		4	HAH454	HACNP454	HACRP454	-
		5	HAH455	HACNP455	HACRP455	-
		6	HAH456	HACNP456	HACRP456	-
Titanium Healing Cap, wide	5.5	2	HAH552	-	HACRP552	-
		3	HAH553	-	HACRP553	-
		4	HAH554	-	HACRP554	-
		5	HAH555	-	HACRP555	-
		6	HAH556	-	HACRP556	-
	6.0	2	HAH602	-	HACRP602	-
		3	HAH603	-	HACRP603	-
		4	HAH604	-	HACRP604	-
		5	HAH605	-	HACRP605	-
		6	HAH606	-	HACRP606	-
Zirconia Healing Cap*	3.5	2	-	-	-	ZHCSP352
		3	-	-	-	ZHCSP353
		4	-	-	-	ZHCSP354
		5	-	-	-	ZHCSP355
		6	-	-	-	ZHCSP356
	3.8	2	ZHCH382	ZHCNP382	ZHCRP382	-
		3	ZHCH383	ZHCNP383	ZHCRP383	-
		4	ZHCH384	ZHCNP384	ZHCRP384	-
		6	ZHCH386	ZHCNP386	ZHCRP386	-
		4.3	3	ZHCH433	ZHCNP433	ZHCRP433
	4		ZHCH434	ZHCNP434	ZHCRP434	-
	5.5	3	ZHCH553	-	ZHCRP553	-
		4	ZHCH554	-	ZHCRP554	-

Titanium Healing Cap

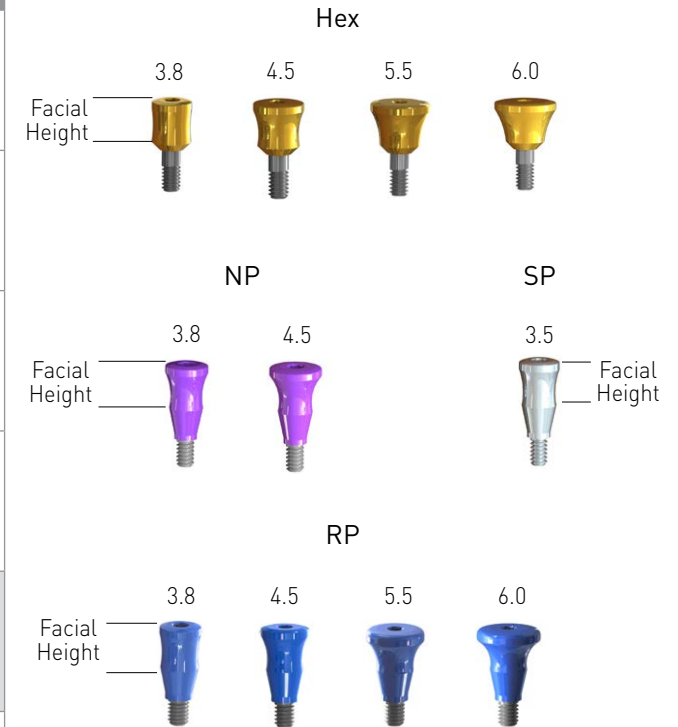

Zirconia Healing Cap



*Call for more information.

Cover Screws

Zero height abutments for covered healing (two-stage surgery).

Hex (for Ø3.5, Ø4.3, Ø5.0, and Ø6.0 implants)

NP (for Ø3.5 implants)

RP (for Ø4.3, Ø5.0, and Ø6.0 implants)

SP (for Ø3.0 implants)

Diameter (mm)	Hex Catalog No.	NP Conical Catalog No.	RP Conical Catalog No.	Slim Conical Catalog No.
3.0	-	-	-	CSCSP30S
3.5	CSH35Y	CSCNP35P	-	-
4.3	CSH43Y	-	CSCR43B	-
5.0	CSH50Y	-	CSCR50B	-
6.0	CSH60Y	-	CSCR60B	-



Hex

NP

RP

SP

Implant Carrier

Shank Height (mm)	Hex Catalog No.	NP Conical Catalog No.	RP Conical Catalog No.	Slim Conical Catalog No.
5	ICH5	ICNP5	ICRP5	ICCS5
10	ICH10	ICNP10	ICRP10	ICCS10



Impression Transfer

Available for both open-tray and closed-tray techniques.

Open Tray: transfer screw supplied with both long and short pickups

Length (mm)	10	15	Transfer Screw
Hex Catalog No.	ITOH10	ITOH15	ITSH
NP Conical Catalog No.	ITONCNP10	ITONCNP15	ITSCNP
RP Conical Catalog No.	ITONCRP10	ITONCRP15	ITSCR
Slim Conical Catalog No.	ITOCSP10	ITOCSP15	ITSCSP

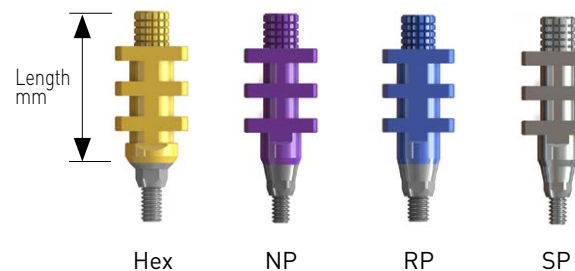

Hex

NP

RP

SP

Closed Tray: long and short transfers

Length (mm)	10	15
Hex Catalog No.	ITCH10	ITCH15
NP Conical Catalog No.	ITCCNP10	ITCCNP15
RP Conical Catalog No.	ITCCRP10	ITCCRP15
Slim Conical Catalog No.	ITCCSP10	ITCCSP15

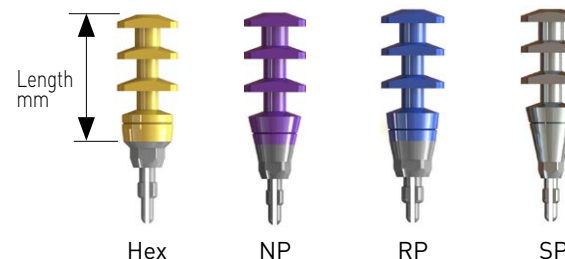

Hex

NP



RP

SP

Cement/Screw Retained Abutments

Prefabricated Flat & Anatomic Abutments with Conical or Hex Connections

Hex (for Ø3.5, Ø4.3, Ø5.0, Ø6.0 implants) NP (for Ø3.5 implants) RP (for Ø4.3, Ø5.0, Ø6.0 implants) SP (for Ø3.0 implants) with shoulder/cuff collar design

Design	Diameter (mm)	Facial Height (mm)	Hex Catalog No.	NP Conical Catalog No.	RP Conical Catalog No.	Design	Diameter (mm)	Facial Height (mm)	Slim Catalog No.
Flat (Titanium, Narrow)	3.8	5	FTAH3805	FTACNP3805	FTACRP3805	Flat (Titanium, Slim)	3.7	1	FSACSP3710
		7	FTAH3807	FTACNP3807	FTACRP3807			2	FSACSP3720
		9	FTAH3809	FTACNP3809	FTACRP3809			3	FSACSP3730
		11	FTAH3811	FTACNP3811	FTACRP3811				
Flat (Titanium, Standard)	4.5	5	FTAH4505	FTACNP4505	FTACRP4505	Angulated 15° (Titanium, Slim)	3.7	1	15ASACSP3710
		7	FTAH4507	FTACNP4507	FTACRP4507			2	15ASACSP3720
		9	FTAH4509	FTACNP4509	FTACRP4509			3	15ASACSP3730
		11	FTAH4511	FTACNP4511	FTACRP4511				
Flat (Titanium, Wide)	5.5	5	FSAH5505	-	FTSARP5505				
		7	FSAH5507	-	FTSARP5507				
		9	FSAH5509	-	FTSARP5509				
		11	FSAH5511	-	FTSARP5511				
Abutment with Shoulder (Titanium)	3.8	1	TASH3810	TASCNP3810	TASCRP3810				
		2	TASH3820	TASCNP3820	TASCRP3820				
		3	TASH3830	TASCNP3830	TASCRP3830				
	4.5	1	TASH4510	TASCNP4510	TASCRP4510				
		2	TASH4520	TASCNP4520	TASCRP4520				
		3	TASH4530	TASCNP4530	TASCRP4530				
	5.5	4	TASH4540	TASCNP4540	TASCRP4540				
		1	TASH5510	-	TASCRP5510				
		2	TASH5520	-	TASCRP5520				
Anatomic (Titanium)	4.5	3	ATAH4530	ATACNP4530	ATACRP4530				
		4	ATAH4540	ATACNP4540	ATACRP4540				
		1	ATAH5210	-	ATACRP5210				
	5.2	2	ATAH5220	-	ATACRP5220				
		3	ATAH5230	-	ATACRP5230				
		1	15ATAH4710	15ATACNP4710	15ATACRP4710				
15° Angulated (Titanium)	4.7	2	15ATAH4720	15ATACNP4720	15ATACRP4720				
		3	15ATAH4730	15ATACNP4730	15ATACRP4730				
		1	25ATAH5210	25ATACNP5210	25ATACRP5210				
25° Angulated (Titanium)	5.2	2	25ATAH5220	25ATACNP5220	25ATACRP5220				
		3	25ATAH5230	25ATACNP5230	25ATACRP5230				

Anatomic Hex

Cement-Retained Abutments

Anatomic Zirconia Abutments with Conical or Hex Connections*

Hex (for Ø3.5, Ø4.3, Ø5.0 and Ø6.0 implants)

NP (for Ø3.5 implants)

RP (for Ø4.3, Ø5.0, Ø6.0 implants)

SP (for Ø3.0 implants)

Design	Diameter (mm)	Facial Height	Hex Catalog No.	NP Conical Catalog No.	RP Conical Catalog No.	Slim Conical Catalog No.
Anatomic zirconia with titanium base	3.5	1	-	-	-	AZACTSP3510
		2	-	-	-	AZACTSP3520
		3	-	-	-	AZACTSP3530
		4	-	-	-	AZACTSP3540
		5	-	-	-	AZACTSP3550
	5.0	1	AZAHT5010	AZACTNP5010	AZACTRP5010	-
		2	AZAHT5020	AZACTNP5020	AZACTRP5020	-
		3	AZAHT5030	AZACTNP5030	AZACTRP5030	-
		4	AZAHT5040	AZACTNP5040	AZACTRP5040	-
		5	AZAHT5050	AZACTNP5050	AZACTRP5050	-

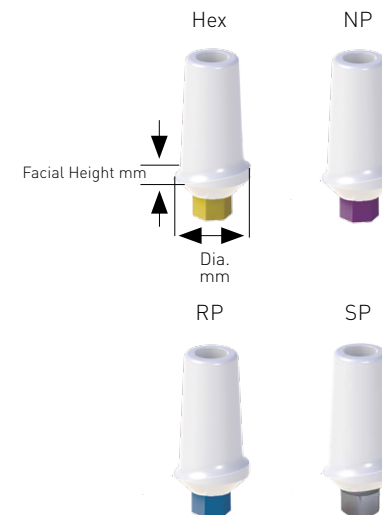

*Call for more information.

Angulated 15° zirconia abutments available in European market.

Call your SpiralTech representative for additional information.

Abutments—PEEK Temporary

Esthetic with Hex/Conical Connection*

Design	Length (mm)	Facial Height (mm)	Hex Catalog No.	NP Conical Catalog No.	RP Conical Catalog No.	Slim Conical Catalog No.
Ø4.5 Abutment with Shoulder	10	1	PAH1001	PACNP1001	PACRP1001	PACSP1001
	11	2	PAH1102	PACNP1102	PACRP1102	PACSP1102
	12	3	PAH1203	PACNP1203	PACRP1203	PACSP1203
Ø4.5 Anatomic	10	1	APAH1001	APACNP1001	APACRP1001	APACSP1001
	11	2	APAH1102	APACNP1102	APACRP1102	APACSP1102
	12	3	APAH1203	APACNP1203	APACRP1203	APACSP1203



* Call for more information.

Screw-Retained & Multi-Unit Restorations

Our Multi-Unit Abutment System is designed for restoration of partially or fully edentulous arch cases.

Straight Multi Abutments



Facial Height (mm)	1	2	3	4
Hex Catalog No.	00MUAH1	00MUAH2	00MUAH3	00MUAH4
NP Conical Catalog No.	00MUANP1	00MUANP2	00MUANP3	00MUANP4
RP Conical Catalog No.	00MUARP1	00MUARP2	00MUARP3	00MUARP4

Angled 17° Multi Abutments



Hex Catalog No.	17MUAH1	17MUAH2	17MUAH3	-
NP Conical Catalog No.	17MUANP1	17MUANP2	17MUANP3	-
RP Conical Catalog No.	17MUARP1	17MUARP2	17MUARP3	-

Angled 30° Multi Abutments



Hex Catalog No.	30MUAH1	30MUAH2	30MUAH3	-
NP Conical Catalog No.	30MUANP1	30MUANP2	30MUANP3	-
RP Conical Catalog No.	30MUARP1	30MUARP2	30MUARP3	-



Straight Multi Unit System
CATALOG NO. MUS

Angled 17° Multi Unit System
CATALOG NO. 17MUS

Angled 30° Multi Unit System
CATALOG NO. 30MUS

Abutment Accessories and Prosthetics

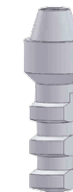

Catalog No.	MUPS0032	MUTS1250	MTMU1200	MTMU8005	MWQP0011	MHCC4550	MAMU1201	MSMU4023
Description	Plastic Sleeve screw included	Titanium Sleeve screw included	Open Tray Transfer screw included	Closed Tray Transfer	Plastic for Closed Tray Transfer	Heating cap for Multi-Unit	Analog for Multi-Unit	Screw for Multi-Unit Sleeve

Implant Prosthetic Indicator (IPI)

Diameter	Height (mm)	Hex Catalog No	NP Conical Catalog No.	RP Conical Catalog No.
3.85	1	LOH1	LOHNP1	LOHRP1
	2	LOH2	LOHNP2	LOHRP2
	3	LOH3	LOHNP3	LOHRP3
	4	LOH4	LOHNP4	LOHRP4
	5	LOH5	LOHNP5	LOHRP5
	6	LOH6	LOHNP6	LOHRP6

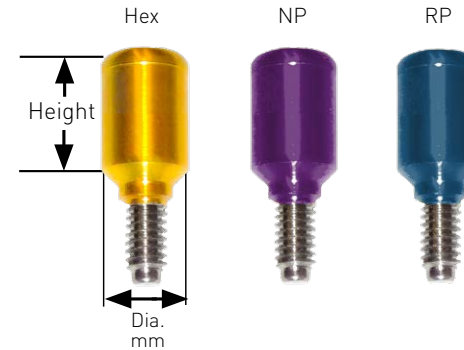







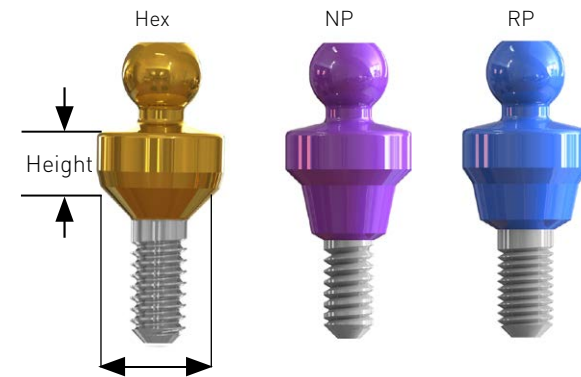

Ball Attachments

Conical and Hex Connection manufactured in Titanium alloy

Design	Diameter (mm)	Facial Height (mm)	Hex Catalog No.	NP Conical Catalog No.	RP Conical Catalog No.
Ball Attachment	4	1	BAH1	BAHNP1	BAHRP1
		2	BAH2	BAHNP2	BAHRP2
		3	BAH3	BAHNP3	BAHRP3
		4	BAH4	BAHNP4	BAHRP4
		5	BAH5	BAHNP5	BAHRP5
		6	BAH6	BAHNP6	BAHRP6



Ball Attachment Covers | Implant Prosthetic Indicator Covers

								
Catalog No.	MAH1	NIS1	NIS2	NIS3	MAC1	NIP1	NIP2	NIP3
Description	Metal (BAC)	Standard Plastic (BAC)	Soft Plastic (BAC)	Hard Plastic (BAC)	Metal (IPI)	Standard Plastic (IPI)	Soft Plastic (IPI)	Hard Plastic (IPI)

Screws and Accessories

Connecting Screws for Impression Transfer

Length	13mm	18mm
Hex Catalog No.	ITSH13	ITSH18
NP Conical Catalog No.	ITSCNP13	ITSCNP18
RP Conical Catalog No.	ITSCR13	ITSCR18
Slim Conical Catalog No.	ITSCSP13	ITSCSP18

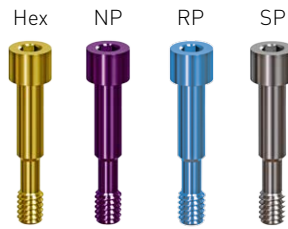

Lab –Titanium based Conical & Hex Plastic Sleeve

Material	Plastic	Plastic & Titanium
Platform	1.00mm	1.00mm
Length	12.00mm	12.00mm
Hex Catalog No.	SP8218	SPT3112
Conical Catalog No.	SPC8218	SPTC3112
Slim Conical Catalog No.	SPCSP8218	SPTCSP3112



Screws

Screws fit all abutments
Utilize 1.25 mm or .050
Hex Driver
Final torque 30 Ncm



Packaged with	Angulated Abutments	Angulated & Straight Abutments	Straight Abutment
Length	7.6mm	8.3mm	9.4mm
Hex Catalog No.	SCA76	SCA83	SCA94
NP Conical Catalog No.	SCACNP76	SCACNP83	SCACNP94
RP Conical Catalog No.	SCACRP76	SCACRP83	SCACRP94
Slim Conical Catalog No.	SCACSP76	SCACSP83	SCACSP94

Lab Analogs

Our Lab Analog indicate location of the implant for the laboratory.



Material	Titanium	Titanium
Diameter	4.00mm	3.00mm
Length	12.00mm	12.00mm
Hex Catalog No.	ECAH	-
NP Conical Catalog No.	ECACNP	-
RP Conical Catalog No.	ECACRP	-
Slim Conical Catalog No.	-	ECACSP30



Surgical Kit—ESi / Premium Implants

One Step Two Grade Drill Bit Kit

SpiralTech surgical trays and drills have been designed to both simplify the surgery and make each step of the process intuitive.

- Drill measurements and drilling protocols printed directly on the tray
- Small tray size allows easy positioning anywhere in the surgical set-up
- Numbered, color-coded drills for easy identification
- Precision fit of instruments into tray—no additional rubber pieces to loosen or fall out



ESi/Premium Surgical Kit
CATALOG NO. SKEP

White Tray Insert Catalog No. STG2
Black Box Catalog No. A6

Surgical Kit—Ultimate Implants

Two Step Three Grade Drill Bit Kit

SpiralTech surgical trays and drills have been designed to both simplify the surgery and make each step of the process intuitive.

- Drill measurements and drilling protocols printed directly on the tray
- Small tray size allows easy positioning anywhere in the surgical set-up
- Numbered, color-coded drills for easy identification
- Precision fit of instruments into tray—no additional rubber pieces to loosen or fall out



Ultimate Surgical Kit
CATALOG NO. SKU

White Tray Insert Catalog No. STG3
Black Box Catalog No. A6

Mini Surgical Kit—ESi / Premium Implants

One Step Two Grade Drill Bit Kit

SpiralTech mini surgical trays and drills have been designed to both simplify the surgery and make each step of the process intuitive.

- Small tray size allows easy positioning anywhere in the surgical set-up
- Numbered, color-coded drills for easy identification
- Precision fit of instruments into tray—no additional rubber pieces to loosen or fall out



ESi/Premium Mini Surgical Kit
CATALOG NO. MSKEP

Mini White Tray Catalog No. MSTG
Mini Black Box Catalog No. A8

Mini Surgical Kit—Ultimate Implants

Two Step Three Grade Drill Bit Kit

SpiralTech mini surgical trays and drills have been designed to both simplify the surgery and make each step of the process intuitive.

- Small tray size allows easy positioning anywhere in the surgical set-up
- Numbered, color-coded drills for easy identification
- Precision fit of instruments into tray—no additional rubber pieces to loosen or fall out



Ultimate Mini Surgical Kit
CATALOG NO. MSKU

Mini White Tray Catalog No. MSTG
Mini Black Box Catalog No. A8

ESi/Premium Surgical Drills and Countersink

Two Grade

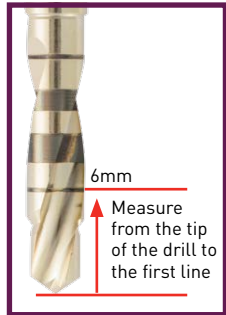

Laser Identification



Color Coding

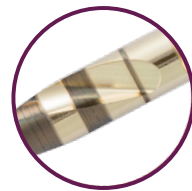

Depth Laser Marked

For
ESi and Premium
One step, two grade

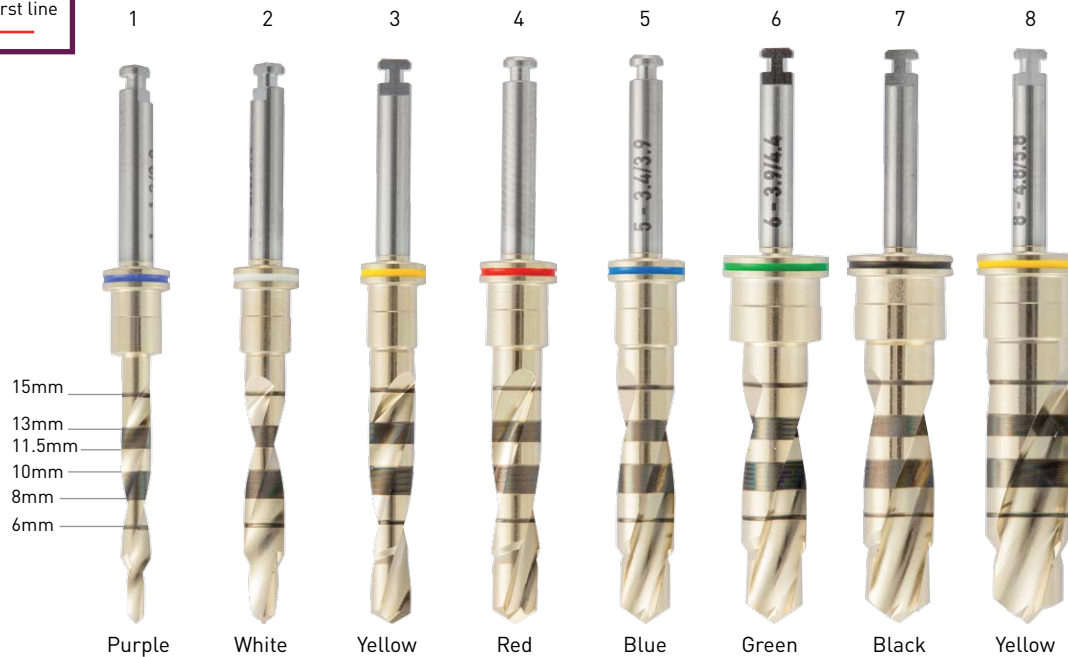

Drill Number	1	2	3	4	5	6	7	8
ESi/Premium	1.2/2.0	2.0/2.8	2.8/3.1	3.1/3.4	3.4/3.9	3.9/4.4	4.4/4.8	4.8/5.8
Catalog No.	ESiPR1	ESiPR2	ESiPR3	ESiPR4	ESiPR5	ESiPR6	ESiPR7	ESiPR8

Countersink	Countersink	1/2 Round	1.5 Spade
3.5-4.3	5.0-6.0	-	-
CURS354	CURS456	05RD	SPADE15

Ultimate Surgical Drills and Countersink

Three Grade

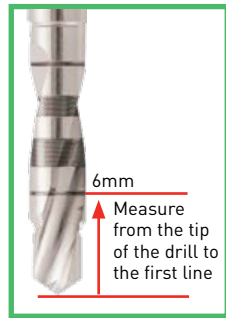

Laser Identification



Color Coding



Depth Laser Marked

For Ultimate Two step, three grade

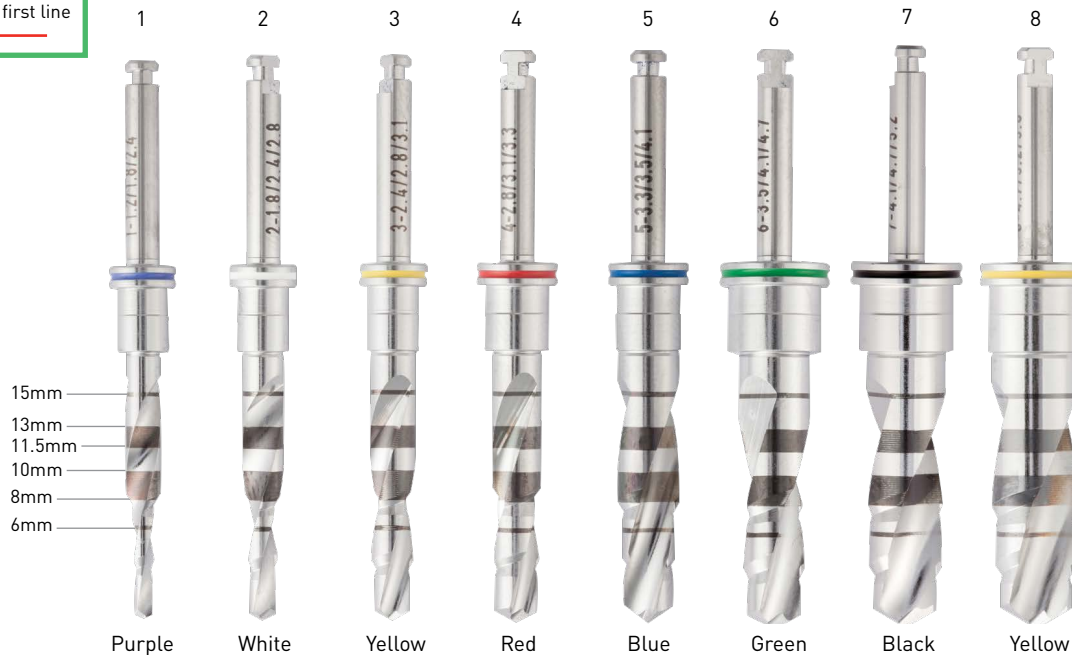

Drill Number	1	2	3	4	5	6	7	8
Ultimate	1.2/1.8/2.4	1.8/2.4/2.8	2.4/2.8/3.1	2.8/3.1/3.3	3.3/3.5/4.1	3.5/4.1/4.7	4.1/4.7/5.2	4.7/5.2/5.8
Catalog No.	DUAL1	DUAL2	DUAL3	DUAL4	DUAL5	DUAL6	DUAL7	DUAL8

Countersink	Countersink	1/2 Round	1.5 Spade
3.5-4.3	5.0-6.0	-	-
CURS354	CURS456	05RD	SPADE15

Drill Stoppers



Implant Length	8	10	11.5	13
Drill #	1,2,3	1,2,3	1,2,3	1,2,3
Stop ø mm	4.5	4.5	4.5	4.5
Implant ø mm	3.5	3.5	3.5	3.5
Stopper length mm	14.3	12.3	10.8	9.3
Laser mark	Red Red	Red Blue	Red Green	Red Yellow
Catalog No.	RRS800	RBS100	RGS115	RYS130



Implant Length	8	10	11.5	13
Drill #	4,5	4,5	4,5	4,5
Stop ø mm	5.3	5.3	5.3	5.3
Implant ø mm	4.3	4.3	4.3	4.3
Stopper length mm	14.3	12.3	10.8	9.3
Laser mark	Blue Red	Blue Blue	Blue Green	Blue Yellow
Catalog No.	BRS800	BBS100	BGS115	BYS130



Implant Length	8	10	11.5	13
Drill #	6,7,8	6,7,8	6,7,8	6,7,8
Stop ø mm	7.2	7.2	7.2	7.2
Implant ø mm	5.0,6.0	5.0,6.0	5.0,6.0	5.0,6.0
Stopper length mm	14.3	12.3	10.8	9.3
Laser mark	Green Red	Green Blue	Green Green	Green Yellow
Catalog No.	GRS800	GBS100	GBS115	GYS113



Drill Stoppers Kit
CATALOG NO. DSK

Mini White Tray Catalog No. STGS
Mini Black Box Catalog No. A8

Length	L8	L10	11.5	L13
Drills	1, 2, 3	1, 2, 3	1, 2, 3	1, 2, 3
Implant Ø	3.5mm	3.5mm	3.5mm	3.5mm
Drills	4, 5	4, 5	4, 5	4, 5
Implant Ø	4.3mm	4.3mm	4.3mm	4.3mm
Drills	6, 7, 8	6, 7, 8	6, 7, 8	6, 7, 8
Implant Ø	5.0mm, 6.0mm	5.0mm, 6.0mm	5.0mm, 6.0mm	5.0mm, 6.0mm

Surgical Tools

MOTOR MOUNTS



Product	Implant Motor Mount Hex .050/1.25	Implant Motor Mount Hex	Implant Motor Mount Conical NP	Implant Motor Mount Conical RP	Drill Extender	Tissue Punch	Depth Gauge
Size	1.25mm	2.42mm	2.25mm	2.65mm	-	∅ 3.0x4.0mm	-
Length	22/28mm	22/28mm	22/28mm	22/28mm	26mm	∅ 4.0x5.0mm	-
Catalog No.	MMH122 MMH128	MMH222 MMH228	MMCNP222 MMCNP228	MMCRP222 MMCRP228	DE26	TPU30/40 TPU40/50	DDM15

RATCHET MOUNTS



Product	Ratchet Abutment Screw Driver Hex	Ratchet Implant Driver Hex	Ratchet Implant Driver Conical NP	Ratchet Implant Driver Conical RP
Size	1.25mm	2.42mm	2.25mm	2.65mm
Length	7mm/15mm	13mm	13mm	13mm
Catalog No.	HXD107 HXD115	HXD213	CDNP213	CDRP213

OTHER TOOLS



Screw Driver

1.25mm 10/15mm

HND10
HND15



Hand Wrench Hex

0.25mm

TWRCHT



Ratchet
WR



Torque Ratchet
TWR

Essentials Surgical Cassette

The Essentials cassette contains all the instruments necessary for successful implant surgery.



Essential Surgical Cassette
Catalog No. ESURCK1



Periodontal Probe (ESC-PP) | Buser Elevator (ESC-BE) | Periosteal Elevator (ESC-PE) | Scalpel Handle (ESC-SH) | Double-sided Mirror and Handle (ESC-DMH) | Adson Tissue Pliers (ESC-ATP) | College Pliers (ESC-CP) | Minnesota Retractor (ESC-MR)



Suction Tip
ESC-ST

Anesthetic Syringe
ESC-AS

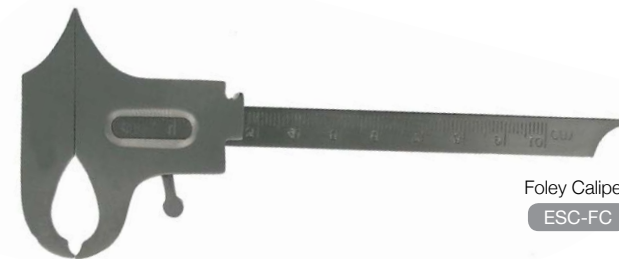

Foley Caliper
ESC-FC



Irrigation Syringe
ESC-IS



Curved Iris Scissors
ESC-CIS



Castroviejo Needle Driver
ESC-CND

Periotome Extraction

For minimally-traumatic extraction of teeth and retained roots. The periotome extraction kit is a critical tool for immediate implant placement.



Periotome Extraction Kit
Catalog No. PEREX

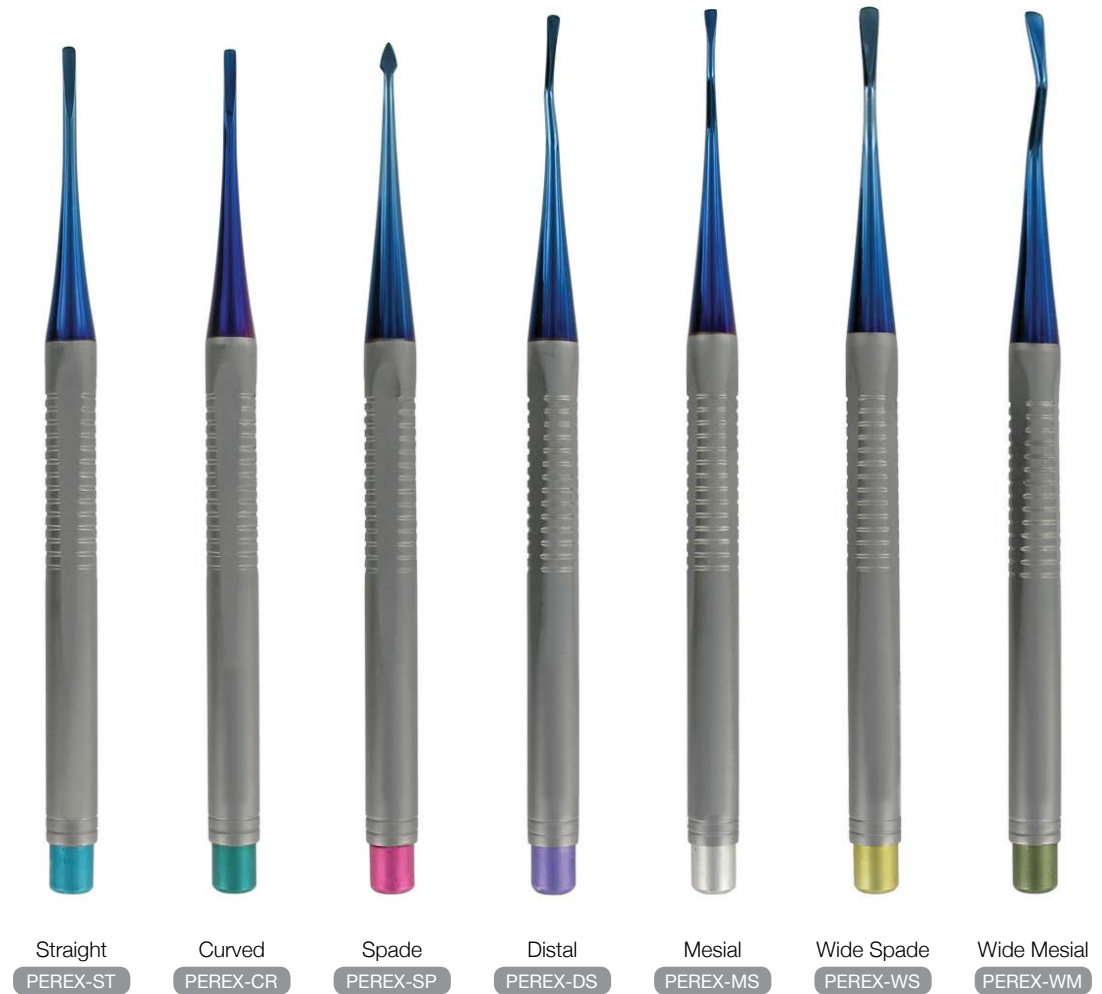

Straight
PEREX-ST

Curved
PEREX-CR

Spade
PEREX-SP

Distal
PEREX-DS

Mesial
PEREX-MS

Wide Spade
PEREX-WS

Wide Mesial
PEREX-WM

Osteotome Sinus Lift

Concave tips to allow the introduction of graft material. Long tips with adjustable depth stops.



Osteotome Sinus Lift
Catalog No. OSTSL

STRAIGHT. OSTSL-S



CURVED OSTSL-C



Implant—Torque

Torque is the surgeon's last tool to use. Surgeons are able to reach deep molar areas without difficulty compared to other torques.



Torque control

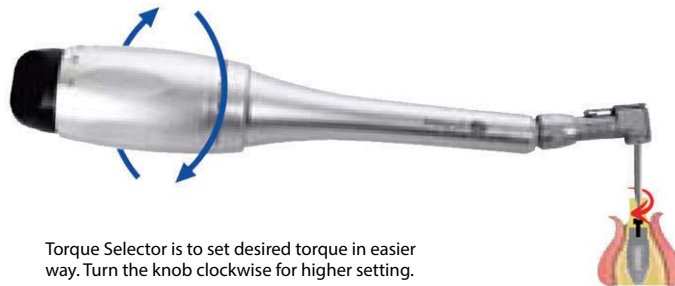

Operation



Bone Expander Kit *For expanding narrow bone ridge.*

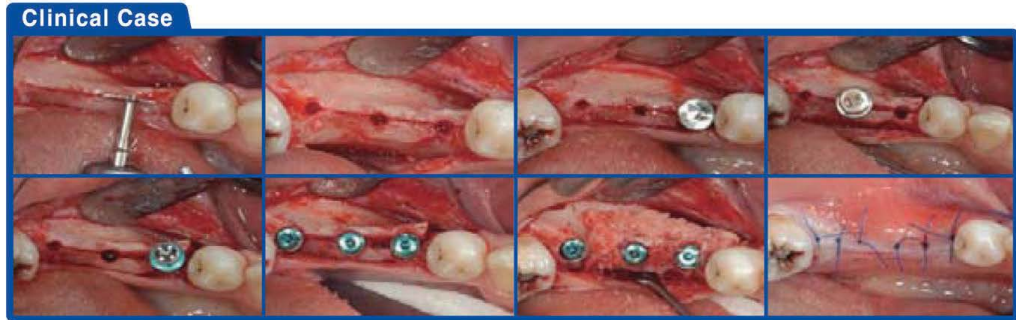

Bone Expander Kit
Catalog No. SBE-01

Our Bone Expander Kit is used for single implants to expand where the bone is narrow width or to improve weak bone.

EXPANDER DRILLS *Easy expansion, no bone loss, less traumatic.*

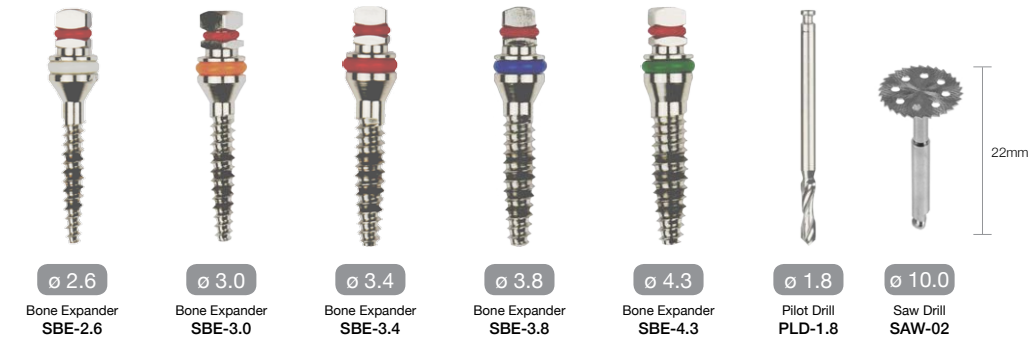

	Diameter	Length	Apical
1 White	ø 2.6	17mm	4mm
			6mm
			8mm
			10mm
			12mm
2 Orange	ø 3.0	17mm	4mm
			6mm
			8mm
			10mm
3 Red	ø 3.4	17mm	4mm
			6mm
			8mm
			10mm
4 Blue	ø 3.8	17mm	4mm
			6mm
			8mm
			10mm
5 Green	ø 4.3	17mm	4mm
			6mm
			8mm
			10mm



Split Master Kit *For Single or Multiple Implanting.*



PILOT DRILL / BONE EXPANDER.

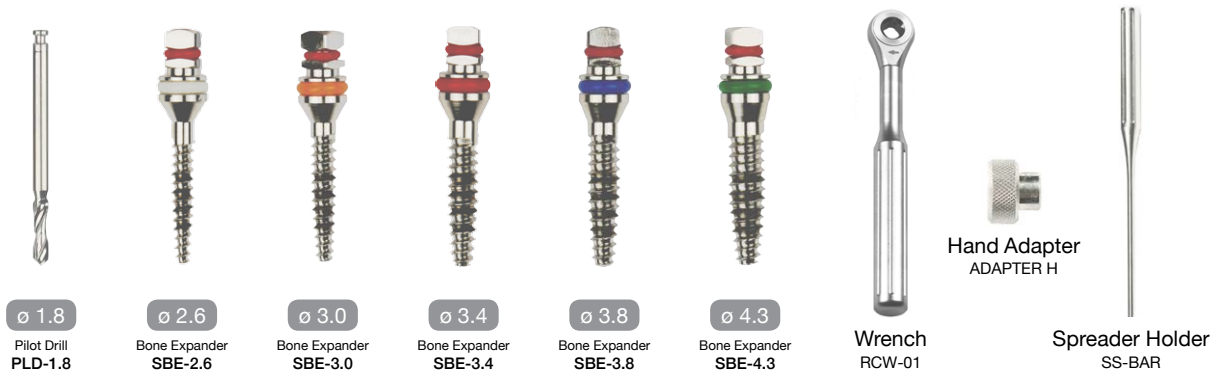

Split Master Kit
Catalog No. SSM-02

Our Split Master Kit is used for single or multiple implanting procedures.

BONE CARRIER SPLIT CHISEL SPC-01 (Set)

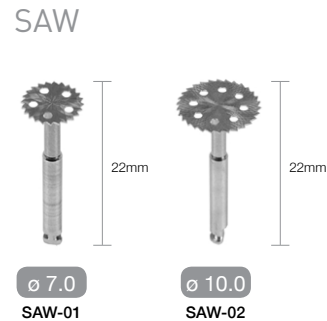
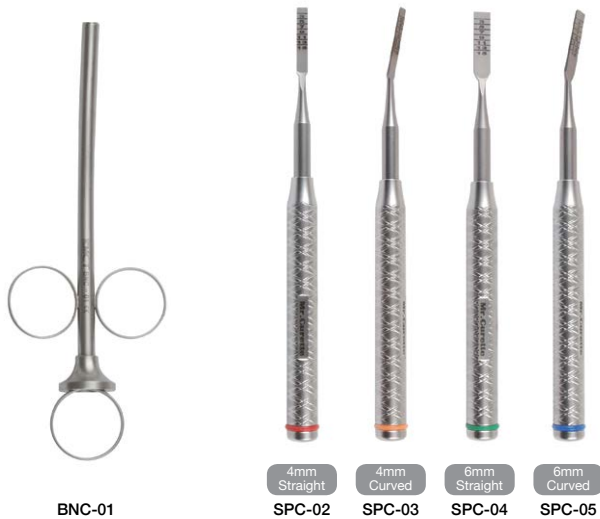

BONE EXPANDER

1. Measure the width of bone.
2. Prepare a pilot osteotomy with the Pilot Drill.
3. Widen the osteotomy with the appropriate Bone Expander.
4. Use extension tool for difficult access between long adjacent teeth.



BONE CRESTER

1. Prepare along the ridge to the desired length using the saw.
2. Deepen the saw cut with the chisels to make space for Spreader.
3. Insert 2 or more Spreaders as required.
4. Expand the bone gradually by adjusting each spreader screw little by little.



Bone Chip Maker *New and improved Bone Chip Maker to save your bone graft cost*



Bone Chip Maker
Catalog No. **BCM2-01**

Our Bone Chip Maker collects bone as you prepare your osteotomy to save your time and bone graft cost.

COMPONENTS

BONE CHIP MAKER TIP

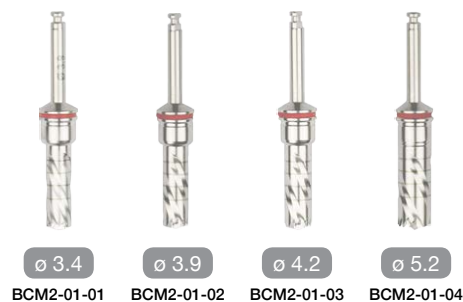

STOPPER

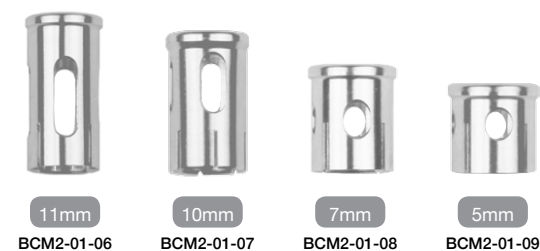

TREPINE BUR



REMOVER



FEATURES

- The blade cylinder is attached to an outer ring for better drilling experience and capacity for bone.
- New depth stops avoid over penetration. A world first!
- Collect bone as you prepare your osteotomy for saving time and bone graft cost.
- Excellent and powerful Z-shaped cutting blade.

DIRECTIONS FOR USE

1. Assemble the Chip Maker with appropriate Depth Stop.
2. Prepare the osteotomy site.
3. Remove the depth stop and separate the blade cylinder from the RA Shank.
4. Remove the bone from the inside of the cylinder Bone Remover.
5. After use, ultrasonic clean and autoclave.



Fixture & Screw Removal Kit *Fixture and Screw Removal Kit Combined*

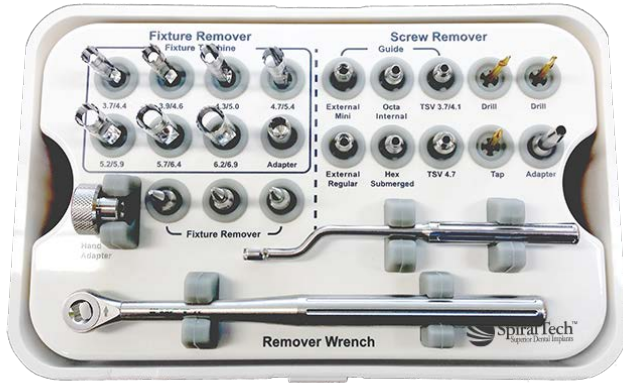

Fixture & Screw Removal Kit
Catalog No. **FSRK-01**

EACH KIT FEATURES...

FIXTURE REMOVAL KIT

1. An excellent combination of Fixture Removers and Trepine Burs for all eventualities.
2. Remover bur removes implants without bone loss.
3. One Remover fits all sizes of implants.
4. Strong and durable.

SCREW REMOVAL KIT

1. Select an appropriate Guide for the damaged abutment.
2. Attach the Guide using the Guide Holder (SRG-H).
3. In Reverse, use the Screw Remover Drill to prepare a channel in the broken screw. The Guide will ensure the channel is in the correct place.
4. Also in Reverse, use the Tap Drill to remove the broken screw.



Fixture Removal Kit
Catalog No. **FRK-01**



Screw Removal Kit
Catalog No. **SRK-01**

FIXTURE REMOVAL KIT FRK-01

Fixture Removal Drill
FRD-01



Fixture Removal Drill Trepine Bur



ø 3.5
FRT-3.7/4.4



ø 3.7
FRT-3.9/4.6



ø 4.1
FRT-4.3/5.0



ø 4.5
FRT-4.7/5.4



ø 5.0
FRT-5.2/5.9



ø 5.5
FRT-5.7/6.4



ø 6.0
FRT-6.2/6.9

SCREW REMOVAL KIT SRK-01

Screw Removal Drills and Tap



Drill SRD-01

Tap SRT-01

Screw Removal Guides



SRG-EM



SRG-IO



SRG-TSV3.7/4.1



SRG-ER



SRG-SH



SRG-TSV4.7

Sinus Master Kit



Sinus Master Kit
Catalog No. **SMK3-01**

FOR LATERAL AND CRESTAL SINUS LIFTING

CRESTER DRILL

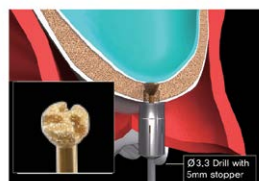

LATERAL DRILL

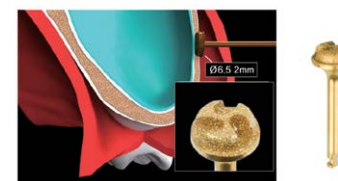

1. A lateral Maxillary window can be created efficiently with the Lateral Drills.
2. For Crestal approach, first use the Crest Drill with appropriate depth stop until the last 1mm.
3. Finish the last 1mm with Crest Reamer with 1mm depth stop attached joined. The Crest Reamer is made of diamond particles to avoid snagging the membrane.
4. Use sinus lift instruments to lift up the sinus membrane.

COMPONENTS

CRESTER DRILLS



CRESTER REAMERS



LATERAL DRILLS AND REAMERS



Sinus Master Kit

COMPONENTS

STOPPERS



AQUA SYSTEM

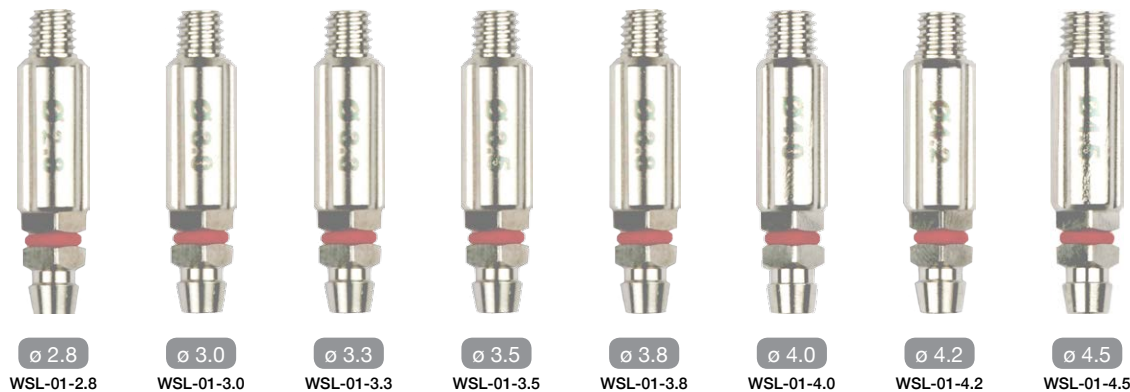

AQUA TIP

1. Insert the Aqua Tip into the osteotomy.
2. Fill the syringe with saline and connect the tubing.
3. Fit the syringe into the Syringe Roller and attach the tubing to the Aqua Tip.
4. To gently lift up the membrane, turn the screw on the Syringe Roller.



Catalog No. **WSL-01-01**

SINUS LIFT



CortiOss *Cortical Bone in Powder and Chip*

Implants must be firmly anchored to the jawbone to be effective. If the jawbone lacks the necessary quality or quantity of bone, bone grafting can strengthen and thicken the implant site.

CortiOss is a Freeze Dried Bone Allograft (FDBA) composed of 100% cortical bone. SpiralTech's freeze-dried cortical bone maintains all the growth factors, proteins, and minerals that are related to promoting new bone formation. Since cortical bone is much denser and harder compared to cancellous bone, its mechanical strength provides excellent structural maintenance. CortiOss can be rehydrated with patient's blood or saline solution and is provided in a specially designed syringe for user's convenience.

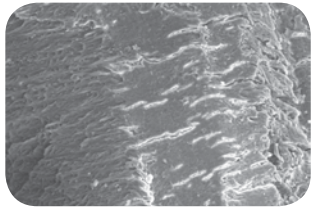

FDBA (Cortical Bone)

- Excellent space maintenance
- Provides lamellar structure that remodels to natural bone
- Indicated for sinus grafting, socket extraction, and ridge augmentation

CortiOss Specification

Product	Type	Particle Size	Size	Catalog No.	Contents
CortiOss	Powder	200-850µm	0.25cc	SOP025	Cortical Bone
			0.5cc	SOP050	
			1.0cc	SOP100	
			2.0cc	SOP200	
Product	Type	Particle Size	Size	Catalog No.	Contents
CortiOss	Chip	850-1500µm	0.25cc	SOC025	Cortical Bone
			0.5cc	SOC050	
			1.0cc	SOC100	
			2.0cc	SOC200	



POWDER TYPE



CHIP TYPE

- **100% freeze dried cortical bone**
- **Cortical structure remodels to host bone**
- **Osteoconductive and Osteoinductive ability**
- **Curved syringe for easy use**
- **Excellent Biocompatibility**

CortiOss-D *Demineralized Cortical Bone in Powder and Chip*

CortiOss-D is a Demineralized Freeze Dried Bone Allograft (DFDBA) composed of 100% demineralized cortical bone. Demineralization increases the osteoinductive ability because growth factors such as BMP becomes viable and induces mesenchymal cells to differentiate into osteoblast. The lyophilization technology made it possible to increase the shelf life DFDBA such as CortiOss-D so it can be stored for a long period of time. CortiOss-D can be rehydrated with patient's blood or saline solution and is provided in a specially designed syringe for user's convenience.

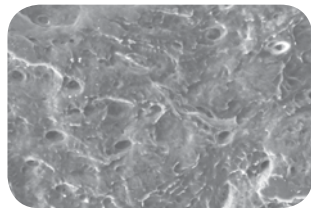

DFDBA (Cortical Bone)

- Demineralized cortical bone matrix without lipid or mineral components.
- Growth factors, such as BMP, help bone regeneration through osteoinduction.

- **100% Demineralized Cortical Bone Allograft**
- **Powerful Osteoinductive ability**
- **Increased shelf life**
- **Curved syringe for easy use**
- **Excellent Biocompatibility**

CortiOss-D Specification

Product	Type	Particle Size	Size	Catalog No.	Contents
CortiOss-D	Powder	200-850µm	0.25cc	DSOP025	Demineralized Cortical Bone
			0.5cc	DSOP050	
			1.0cc	DSOP100	
			2.0cc	DSOP200	
Product	Type	Particle Size	Size	Catalog No.	Contents
CortiOss-D	Chip	850-1500µm	0.25cc	DSOC025	Demineralized Cortical Bone
			0.5cc	DSOC050	
			1.0cc	DSOC100	
			2.0cc	DSOC200	



ConiOss *Cortical and Cancellous Bone in Powder and Chip*

ConiOss is a Freeze Dried Bone Allograft (FDBA) composed of cortical and cancellous bone. Optimized porosity of cancellous bone provides the optimal scaffold for bone tissue to migrate and promote intercellular bone growth. The compactness of the cortical bone is excellent at maintaining structural support as new bone formation occurs. ConiOss can be rehydrated with patient's blood or saline solution and is provided in a specially designed syringe for user's convenience.

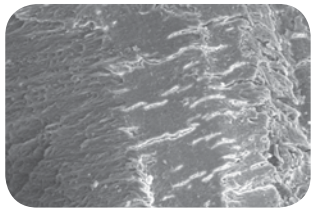

Cortical Bone

- Excellent space maintenance
- Provides lamellar structure that remodels to natural bone
- Indicated for sinus grafting, socket extraction, and ridge augmentation

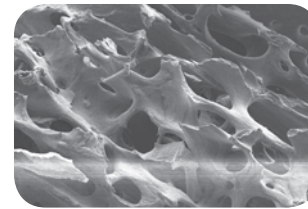

Cancellous Bone

- Open trabecular structure comprised of interconnected pores
- Ideal structure for bone cell infiltration

ConiOss Specification

Product	Type	Particle Size	Size	Catalog No.	Contents
ConiOss	Powder	200-850µm	0.25cc	CCP025	Cortical Bone Cancellous Bone
			0.5cc	CCP050	
			1.0cc	CCP100	
			2.0cc	CCP200	

Product	Type	Particle Size	Size	Catalog No.	Contents
ConiOss	Chip	850-1500µm	0.25cc	CCC025	Cortical Bone Cancellous Bone
			0.5cc	CCC050	
			1.0cc	CCC100	
			2.0cc	CCC200	

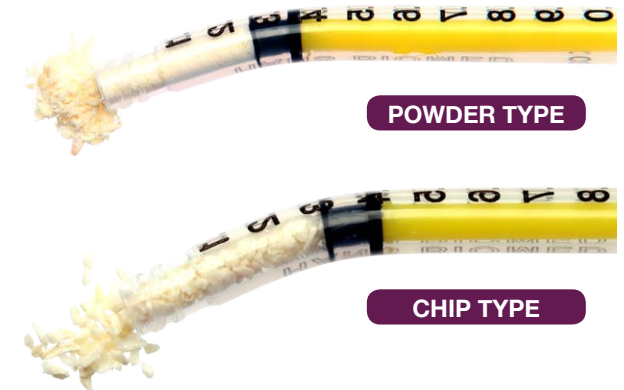

- **100% Freeze Dried Bone Allograft (FDBA)**
- **Great Osteoinductive and Osteoconductive ability**
- **50% Cortical and 50% Cancellous Bone**
- **Curved syringe for easy use**
- **Excellent Biocompatibility**

SpiralTech Motors and Hand-Held Drills

Our SpiralTech Implant Motor is an industry best; it is the most powerful and intelligent implant motor on the market today. It can be used for surgical, implant or endodontic applications; reducing the amount of clutter in the operating room. The adjustable torque is featured and allows you to have complete and precise control.



Oral Surgery Motor
CATALOG NO.
XCIE

Drill Handpiece 1
CATALOG NO.
SIAL201

Drill Handpiece 3
CATALOG NO.
TIAN321

Drill Handpiece 2
CATALOG NO.
TIAN201

Implant Stability Tester
CATALOG NO.
PNST

Accurate ISQ measurement provides greater confidence of when to load the implant. Cordless, light-weight, and very easy to use.

SpiralTech Implant Motor
CATALOG NO.
IMM60

#		
1.5 Spade	SPADE15	28, 29
1/2 Round	05RD	28, 29
15 degree Angulated Titanium Abutment		19
Conical NP (4.7mm, 1mm)	15ATACNP4710	19
Conical NP (4.7mm, 2mm)	15ATACNP4720	19
Conical NP (4.7mm, 3mm)	15ATACNP4730	19
Conical RP (4.7mm, 1mm)	15ATACRP4710	19
Conical RP (4.7mm, 2mm)	15ATACRP4720	19
Conical RP (4.7mm, 3mm)	15ATACRP4730	19
Hex (4.7mm, 1mm)	15ATAH4710	19
Hex (4.7mm, 2mm)	15ATAH4720	19
Hex (4.7mm, 3mm)	15ATAH4730	19
15 degree Angulated Titanium Slim Abutment		19
Slim (3.7mm, 1mm)	15ASACNP3710	19
Slim (3.7mm, 2mm)	15ASACNP3720	19
Slim (3.7mm, 3mm)	15ASACNP3730	19
25 degree Angulated Titanium Abutment		19
Conical NP (5.2mm, 1mm)	25ATACNP5210	19
Conical NP (5.2mm, 2mm)	25ATACNP5220	19
Conical NP (5.2mm, 3mm)	25ATACNP5230	19
Conical RP (5.2mm, 1mm)	25ATACRP5210	19
Conical RP (5.2mm, 2mm)	25ATACRP5220	19
Conical RP (5.2mm, 3mm)	25ATACRP5230	19
Hex (5.2mm, 1mm)	25ATAH5210	19
Hex (5.2mm, 2mm)	25ATAH5220	19
Hex (5.2mm, 3mm)	25ATAH5230	19
A		
Abutment Accessories and Prosthetics		21
Abutment with Shoulder Titanium Abutment		19
Conical NP (3.8mm, 1mm)	TASCNP3810	19
Conical NP (3.8mm, 2mm)	TASCNP3820	19
Conical NP (3.8mm, 3mm)	TASCNP3830	19
Conical NP (4.5mm, 1mm)	TASCNP4510	19
Conical NP (4.5mm, 2mm)	TASCNP4520	19
Conical NP (4.5mm, 3mm)	TASCNP4530	19
Conical NP (4.5mm, 4mm)	TASCNP4540	19
Conical RP (3.8mm, 1mm)	TASCRP3810	19
Conical RP (3.8mm, 2mm)	TASCRP3820	19
Conical RP (3.8mm, 3mm)	TASCRP3830	19
Conical RP (4.5mm, 1mm)	TASCRP4510	19
Conical RP (4.5mm, 2mm)	TASCRP4520	19
Conical RP (4.5mm, 3mm)	TASCRP4530	19
Conical RP (4.5mm, 4mm)	TASCRP4540	19
Conical RP (5.5mm, 1mm)	TASCRP5510	19
Conical RP (5.5mm, 2mm)	TASCRP5520	19
Conical RP (5.5mm, 3mm)	TASCRP5530	19
Hex (3.8mm, 1mm)	TASH3810	19
Hex (3.8mm, 2mm)	TASH3820	19
Hex (3.8mm, 3mm)	TASH3830	19
Hex (4.5mm, 1mm)	TASH4510	19
Hex (4.5mm, 2mm)	TASH4520	19
Hex (4.5mm, 3mm)	TASH4530	19
Hex (4.5mm, 4mm)	TASH4540	19
Hex (5.5mm, 1mm)	TASH5510	19
Hex (5.5mm, 2mm)	TASH5520	19
Hex (5.5mm, 3mm)	TASH5530	19
Adson Tissue Pliers	ESC-ATP	32
Analog for Multi-Unit	MAMU1201	21
Anatomic Titanium Abutment		19
Conical NP (4.5mm, 1mm)	ATACNP4510	19
Conical NP (4.5mm, 2mm)	ATACNP4520	19
Conical NP (4.5mm, 3mm)	ATACNP4530	19
Conical NP (4.5mm, 4mm)	ATACNP4540	19
Conical RP (4.5mm, 1mm)	ATACRP4510	19

Conical RP (4.5mm, 2mm)	ATACRP4520	19
Conical RP (4.5mm, 3mm)	ATACRP4530	19
Conical RP (4.5mm, 4mm)	ATACRP4540	19
Conical RP (5.2mm, 1mm)	ATACRP5210	19
Conical RP (5.2mm, 2mm)	ATACRP5220	19
Conical RP (5.2mm, 3mm)	ATACRP5230	19
Hex (4.5mm, 1mm)	ATAH4510	19
Hex (4.5mm, 2mm)	ATAH4520	19
Hex (4.5mm, 3mm)	ATAH4530	19
Hex (4.5mm, 4mm)	ATAH4540	19
Hex (5.2mm, 1mm)	ATAH5210	19
Hex (5.2mm, 2mm)	ATAH5220	19
Hex (5.2mm, 3mm)	ATAH5230	19
Anatomic Zirconia with Titanium Base Abutment		20
Conical NP (5.0mm, 1mm)	AZACTNP5010	20
Conical NP (5.0mm, 2mm)	AZACTNP5020	20
Conical NP (5.0mm, 3mm)	AZACTNP5030	20
Conical NP (5.0mm, 4mm)	AZACTNP5040	20
Conical NP (5.0mm, 5mm)	AZACTNP5050	20
Conical RP (5.0mm, 1mm)	AZACTRP5010	20
Conical RP (5.0mm, 2mm)	AZACTRP5020	20
Conical RP (5.0mm, 3mm)	AZACTRP5030	20
Conical RP (5.0mm, 4mm)	AZACTRP5040	20
Conical RP (5.0mm, 5mm)	AZACTRP5050	20
Hex (5.0mm, 1mm)	AZAHT5010	20
Hex (5.0mm, 2mm)	AZAHT5020	20
Hex (5.0mm, 3mm)	AZAHT5030	20
Hex (5.0mm, 4mm)	AZAHT5040	20
Hex (5.0mm, 5mm)	AZAHT5050	20
Slim Conical (3.5mm, 1mm)	AZACTSP3510	20
Slim Conical (3.5mm, 2mm)	AZACTSP3520	20
Slim Conical (3.5mm, 3mm)	AZACTSP3530	20
Slim Conical (3.5mm, 4mm)	AZACTSP3540	20
Slim Conical (3.5mm, 5mm)	AZACTSP3550	20
Anesthetic Syringe	ESC-AS	32
Angled 17 degree Multi-Unit Abutment Conical NP (1mm)	17MUANP1	21
Angled 17 degree Multi-Unit Abutment Conical NP (2mm)	17MUANP2	21
Angled 17 degree Multi-Unit Abutment Conical NP (3mm)	17MUANP3	21
Angled 17 degree Multi-Unit Abutment Conical NP (1mm)	17MUARP1	21
Angled 17 degree Multi-Unit Abutment Conical RP (2mm)	17MUARP2	21
Angled 17 degree Multi-Unit Abutment Conical RP (3mm)	17MUARP3	21
Angled 17 degree Multi-Unit Abutment Hex (1mm)	17MUAH1	21
Angled 17 degree Multi-Unit Abutment Hex (2mm)	17MUAH2	21
Angled 17 degree Multi-Unit Abutment Hex (3mm)	17MUAH3	21
Angled 17 degree Multi Unit System	17MUS	21
Angled 30 degree Multi-Unit Abutment Conical NP (1mm)	30MUANP1	21
Angled 30 degree Multi-Unit Abutment Conical NP (2mm)	30MUANP2	21
Angled 30 degree Multi-Unit Abutment Conical NP (3mm)	30MUANP3	21
Angled 30 degree Multi-Unit Abutment Conical RP (1mm)	30MUARP1	21
Angled 30 degree Multi-Unit Abutment Conical RP (2mm)	30MUARP2	21
Angled 30 degree Multi-Unit Abutment Conical RP (3mm)	30MUARP3	21
Angled 30 degree Multi-Unit Abutment Hex (1mm)	30MUAH1	21
Angled 30 degree Multi-Unit Abutment Hex (2mm)	30MUAH2	21
Angled 30 degree Multi-Unit Abutment Hex (3mm)	30MUAH3	21
Angled 30 degree Multi Unit System	30MUS	21
Angulated Abutment Screw Conical NP (7.6mm)	SCACNP76	23
Angulated Abutment Screw Conical RP (7.6mm)	SCACRP76	23
Angulated Abutment Screw Hex (7.6mm)	SCA76	23
Angulated Abutment Screw Slim Conical (7.6mm)	SCACSP76	23
Angulated & Straight Abutment Screw Conical NP (8.3mm)	SCACNP83	23
Angulated & Straight Abutment Screw Conical RP (8.3mm)	SCACRP83	23
Angulated & Straight Abutment Screw Hex (8.3mm)	SCA83	23
Angulated & Straight Abutment Screw Slim Conical (8.3mm)	SCACSP83	23
Aqua System		41
Aqua System (2.8mm)	WSL-01-2.8	41
Aqua System (3.0mm)	WSL-01-3.0	41
Aqua System (3.3mm)	WSL-01-3.3	41

Aqua System (3.5mm)	WSL-01-3.5	41
Aqua System (3.8mm)	WSL-01-3.8	41
Aqua System (4.0mm)	WSL-01-4.0	41
Aqua System (4.2mm)	WSL-01-4.2	41
Aqua System (4.5mm)	WSL-01-4.5	41
Aqua Tip	WSL-01-01	41

B

Ball Attachment		22
Ball Attachment Conical NP (4mm, 1mm)	BAHNP1	22
Ball Attachment Conical NP (4mm, 2mm)	BAHNP2	22
Ball Attachment Conical NP (4mm, 3mm)	BAHNP3	22
Ball Attachment Conical NP (4mm, 4mm)	BAHNP4	22
Ball Attachment Conical NP (4mm, 5mm)	BAHNP5	22
Ball Attachment Conical NP (4mm, 6mm)	BAHNP6	22
Ball Attachment Conical RP (4mm, 1mm)	BAHRP1	22
Ball Attachment Conical RP (4mm, 2mm)	BAHRP2	22
Ball Attachment Conical RP (4mm, 3mm)	BAHRP3	22
Ball Attachment Conical RP (4mm, 4mm)	BAHRP4	22
Ball Attachment Conical RP (4mm, 5mm)	BAHRP5	22
Ball Attachment Conical RP (4mm, 6mm)	BAHRP6	22
Ball Attachment Hex (4mm, 1mm)	BAH1	22
Ball Attachment Hex (4mm, 2mm)	BAH2	22
Ball Attachment Hex (4mm, 3mm)	BAH3	22
Ball Attachment Hex (4mm, 4mm)	BAH4	22
Ball Attachment Hex (4mm, 5mm)	BAH5	22
Ball Attachment Hex (4mm, 6mm)	BAH6	22
Ball Attachment Cover		22
Hard Plastic	NIS3	22
Metal	MAH1	22
Soft Plastic	NIS2	22
Standard Plastic	NIS1	22
Black Box for Surgical Kits	A6	24-25
Bone Carrier	BNC-01	37
Bone Chip Maker	BCM2-01	38
Bone Chip Maker Tip		38
Bone Chip Maker Tip (3.4mm)	BCM2-01-01	38
Bone Chip Maker Tip (3.9mm)	BCM2-01-02	38
Bone Chip Maker Tip (4.2mm)	BCM2-01-03	38
Bone Chip Maker Tip (5.2mm)	BCM2-01-04	38
Bone Remover	BCM2-01-05	38
Stopper		38
Stopper (5mm)	BCM2-01-09	38
Stopper (7mm)	BCM2-01-08	38
Stopper (10mm)	BCM2-01-07	38
Stopper (11mm)	BCM2-01-06	38
Trephine Bur	TPB-08	38
Bone Expander Kit	SBE-01	36
Expander Drills		36
Bone Expander Drill (2.6mm)	SBE-2.6	36, 37
Bone Expander Drill (3.0mm)	SBE-3.0	36, 37
Bone Expander Drill (3.4mm)	SBE-3.4	36, 37
Bone Expander Drill (3.8mm)	SBE-3.8	36, 37
Bone Expander Drill (4.3mm)	SBE-4.3	36, 37
Pilot Drill (1.8mm)	PLD-1.8	36, 37
Saw Drill (10mm)	SAW-02	36, 37
Buser Elevator	ESC-BE	32
C		
Castroviejo Needle Driver	ESC-CND	32
Cement-Retained Abutments		20
Closed Tray Impression Transfer		18
Conical NP (10mm)	ITCCNP10	18
Conical NP (15mm)	ITCCNP15	18
Conical RP (10mm)	ITCCRP10	18
Conical RP (15mm)	ITCCRP15	18

INDEX

Hex (10mm).....	ITCH10.....	18
Hex (15mm).....	ITCH15.....	18
Slim Conical (10mm).....	ITCCSP10.....	18
Slim Conical (15mm).....	ITCCSP15.....	18
Closed Tray Transfer.....	MTMU8005.....	21
College Pliers.....	ESC-CP.....	32
ConiOss		44
Chip.....		44
ConiOss Chip 0.25cc.....	CCC025.....	44
ConiOss Chip 0.50cc.....	CCC050.....	44
ConiOss Chip 1.0cc.....	CCC100.....	44
ConiOss Chip 2.0cc.....	CCC200.....	44
Powder.....		44
ConiOss Powder 0.25cc.....	CCP025.....	44
ConiOss Powder 0.50cc.....	CCP050.....	44
ConiOss Powder 1.0cc.....	CCP100.....	44
ConiOss Powder 2.0cc.....	CCP200.....	44
Connecting Screws for Impression Transfer		23
Connecting Screw Conical NP (13mm).....	ITSCNP13.....	23
Connecting Screw Conical NP (18mm).....	ITSCNP18.....	23
Connecting Screw Conical RP (13mm).....	ITSCR13.....	23
Connecting Screw Conical RP (18mm).....	ITSCR18.....	23
Connecting Screw Hex (13mm).....	ITSH13.....	23
Connecting Screw Hex (18mm).....	ITSH18.....	23
Connecting Screw Slim Conical (13mm).....	ITSCSP13.....	23
Connecting Screw Slim Conical (18mm).....	ITSCSP18.....	23
CortiOss		42
Chip.....		42
CortiOss Chip 0.25cc.....	SOC025.....	42
CortiOss Chip 0.50cc.....	SOC050.....	42
CortiOss Chip 1.0cc.....	SOC100.....	42
CortiOss Chip 2.0cc.....	SOC200.....	42
Powder.....		42
CortiOss Powder 0.25cc.....	SOP025.....	42
CortiOss Powder 0.50cc.....	SOP050.....	42
CortiOss Powder 1.0cc.....	SOP100.....	42
CortiOss Powder 2.0cc.....	SOP200.....	42
CortiOss-D		43
Chip.....		43
CortiOss-D Chip 0.25cc.....	DSOC025.....	43
CortiOss-D Chip 0.50cc.....	DSOC050.....	43
CortiOss-D Chip 1.0cc.....	DSOC100.....	43
CortiOss-D Chip 2.0cc.....	DSOC200.....	43
Powder.....		43
CortiOss-D Powder 0.25cc.....	DSOP025.....	43
CortiOss-D Powder 0.50cc.....	DSOP050.....	43
CortiOss-D Powder 1.0cc.....	DSOP100.....	43
CortiOss-D Powder 2.0cc.....	DSOP200.....	43
Countersink.....	CURS456.....	28
Countersink.....	CURS354.....	29
Cover Screws		18
Conical NP (3.5mm).....	CSCNP35P.....	18
Conical RP (4.3mm).....	CSCR43B.....	18
Conical RP (5.0mm).....	CSCR50B.....	18
Conical RP (6.0mm).....	CSCR60B.....	18
Hex (3.5mm).....	CSH35Y.....	18
Hex (4.3mm).....	CSH43Y.....	18
Hex (5.0mm).....	CSH50Y.....	18
Hex (6.0mm).....	CSH60Y.....	18
Slim Conical (3.0mm).....	CSCSP30S.....	18
Crester Drills		40
Crester Drill (2.0mm).....	CD-2.0.....	40
Crester Drill (2.5mm).....	CD-2.5.....	40
Crester Drill (2.8mm).....	CD-2.8.....	40
Crester Drill (3.3mm).....	CD-3.3.....	40
Crester Drill (3.8mm).....	CD-3.8.....	40
Crester Drill (4.2mm).....	CD-4.2.....	40

Crester Reamers.....		40
Crester Reamer (2.8mm).....	SMK2-02-2.8.....	40
Crester Reamer (3.3mm).....	SMK2-02-3.3.....	40
Crester Reamer (3.8mm).....	SMK2-02-3.8.....	40
Crester Reamer (4.2mm).....	SMK2-02-4.2.....	40
Curved Iris Scissors.....	ESC-CIS.....	32
Curved Osteotome Sinus Lift.....	OSTSL-C.....	34

D

Depth Gauge.....	DDM15.....	31
Double-Sided Mirror and Handle.....	ESC-DMH.....	32
Drill Extender (26mm).....	DE26.....	31
Drill Handpiece 1.....	SIAL201.....	45
Drill Handpiece 2.....	TIAN201.....	45
Drill Handpiece 3.....	TIAN321.....	45
Drill Stoppers Kit.....	DSK.....	30
Drill Stopper (9.3mm, Blue Yellow).....	BYS130.....	30
Drill Stopper (9.3mm, Green Yellow).....	GYS113.....	30
Drill Stopper (9.3mm, Red Yellow).....	RYS130.....	30
Drill Stopper (10.8mm, Blue Green).....	BGS115.....	30
Drill Stopper (10.8mm, Green Green).....	GGS115.....	30
Drill Stopper (10.8mm, Red Green).....	RGS115.....	30
Drill Stopper (12.3mm, Blue Blue).....	BBS100.....	30
Drill Stopper (12.3mm, Green Blue).....	GBS100.....	30
Drill Stopper (12.3mm, Red Blue).....	RBS100.....	30
Drill Stopper (14.3mm, Blue Red).....	BRS800.....	30
Drill Stopper (14.3mm, Green Red).....	GRS800.....	30
Drill Stopper (14.3mm, Red Red).....	RRS800.....	30

E

ESI Implant.....		10
Essential Spectrum Implant Conical (3.0mm, 10mm).....	ESIC30010.....	11
Essential Spectrum Implant Conical (3.0mm, 11mm).....	ESIC30011.....	11
Essential Spectrum Implant Conical (3.0mm, 13mm).....	ESIC30013.....	11
Essential Spectrum Implant Conical (3.0mm, 15mm).....	ESIC30015.....	11
Essential Spectrum Implant Conical (3.5mm, 8mm).....	ESIC35008.....	11
Essential Spectrum Implant Conical (3.5mm, 10mm).....	ESIC35010.....	11
Essential Spectrum Implant Conical (3.5mm, 11mm).....	ESIC35011.....	11
Essential Spectrum Implant Conical (3.5mm, 13mm).....	ESIC35013.....	11
Essential Spectrum Implant Conical (3.5mm, 15mm).....	ESIC35015.....	11
Essential Spectrum Implant Conical (4.3mm, 6mm).....	ESIC43006.....	11
Essential Spectrum Implant Conical (4.3mm, 8mm).....	ESIC43008.....	11
Essential Spectrum Implant Conical (4.3mm, 10mm).....	ESIC43010.....	11
Essential Spectrum Implant Conical (4.3mm, 11mm).....	ESIC43011.....	11
Essential Spectrum Implant Conical (4.3mm, 13mm).....	ESIC43013.....	11
Essential Spectrum Implant Conical (4.3mm, 15mm).....	ESIC43015.....	11
Essential Spectrum Implant Conical (5.0mm, 6mm).....	ESIC50006.....	11
Essential Spectrum Implant Conical (5.0mm, 8mm).....	ESIC50008.....	11
Essential Spectrum Implant Conical (5.0mm, 10mm).....	ESIC50010.....	11
Essential Spectrum Implant Conical (5.0mm, 11mm).....	ESIC50011.....	11
Essential Spectrum Implant Conical (5.0mm, 13mm).....	ESIC50013.....	11
Essential Spectrum Implant Conical (5.0mm, 15mm).....	ESIC50015.....	11
Essential Spectrum Implant Conical (6.0mm, 6mm).....	ESIC60006.....	11
Essential Spectrum Implant Conical (6.0mm, 8mm).....	ESIC60008.....	11
Essential Spectrum Implant Conical (6.0mm, 10mm).....	ESIC60010.....	11
Essential Spectrum Implant Conical (6.0mm, 11mm).....	ESIC60011.....	11
Essential Spectrum Implant Conical (6.0mm, 13mm).....	ESIC60013.....	11
Essential Spectrum Implant Conical (6.0mm, 15mm).....	ESIC60015.....	11
Essential Spectrum Implant Hex (3.5mm, 8mm).....	ESI35008.....	11
Essential Spectrum Implant Hex (3.5mm, 10mm).....	ESI35010.....	11
Essential Spectrum Implant Hex (3.5mm, 11mm).....	ESI35011.....	11
Essential Spectrum Implant Hex (3.5mm, 13mm).....	ESI35013.....	11
Essential Spectrum Implant Hex (3.5mm, 15mm).....	ESI35015.....	11
Essential Spectrum Implant Hex (4.3mm, 6mm).....	ESI43006.....	11

Essential Spectrum Implant Hex (4.3mm, 8mm).....	ESI43008.....	11
Essential Spectrum Implant Hex (4.3mm, 10mm).....	ESI43010.....	11
Essential Spectrum Implant Hex (4.3mm, 11mm).....	ESI43011.....	11
Essential Spectrum Implant Hex (4.3mm, 13mm).....	ESI43013.....	11
Essential Spectrum Implant Hex (4.3mm, 15mm).....	ESI43015.....	11
Essential Spectrum Implant Hex (5.0mm, 6mm).....	ESI50006.....	11
Essential Spectrum Implant Hex (5.0mm, 8mm).....	ESI50008.....	11
Essential Spectrum Implant Hex (5.0mm, 10mm).....	ESI50010.....	11
Essential Spectrum Implant Hex (5.0mm, 11mm).....	ESI50011.....	11
Essential Spectrum Implant Hex (5.0mm, 13mm).....	ESI50013.....	11
Essential Spectrum Implant Hex (5.0mm, 15mm).....	ESI50015.....	11
Essential Spectrum Implant Hex (6.0mm, 6mm).....	ESI60006.....	11
Essential Spectrum Implant Hex (6.0mm, 8mm).....	ESI60008.....	11
Essential Spectrum Implant Hex (6.0mm, 10mm).....	ESI60010.....	11
Essential Spectrum Implant Hex (6.0mm, 11mm).....	ESI60011.....	11
Essential Spectrum Implant Hex (6.0mm, 13mm).....	ESI60013.....	11
Essential Spectrum Implant Hex (6.0mm, 15mm).....	ESI60015.....	11
ESI/Premium Surgical Drills.....		28
ESI/Premium Surgical Drill 1.....	ESIPR1.....	28
ESI/Premium Surgical Drill 2.....	ESIPR2.....	28
ESI/Premium Surgical Drill 3.....	ESIPR3.....	28
ESI/Premium Surgical Drill 4.....	ESIPR4.....	28
ESI/Premium Surgical Drill 5.....	ESIPR5.....	28
ESI/Premium Surgical Drill 6.....	ESIPR6.....	28
ESI/Premium Surgical Drill 7.....	ESIPR7.....	28
ESI/Premium Surgical Drill 8.....	ESIPR8.....	28
Essentials Surgical Cassette.....	ESURCK1.....	32
Esthetic Connections.....		23

F

Fixture Removal Drill.....	FRD-01.....	39
Fixture Removal Drill (3.5mm).....	FRT-3.7/4.4.....	39
Fixture Removal Drill (3.7mm).....	FRT-3.9/4.6.....	39
Fixture Removal Drill (4.1mm).....	FRT-4.3/5.0.....	39
Fixture Removal Drill (4.5mm).....	FRT-4.7/5.4.....	39
Fixture Removal Drill (5.0mm).....	FRT-5.2/5.9.....	39
Fixture Removal Drill (5.5mm).....	FRT-5.7/6.4.....	39
Fixture Removal Drill (6.0mm).....	FRT-6.2/6.9.....	39
Fixture Removal Kit.....	FRK-01.....	39
Fixture & Screw Removal Kit.....	FSRK-01.....	39
Flat Titanium Narrow Abutment		19
Conical NP (3.8mm, 5mm).....	FTACNP3805.....	19
Conical NP (3.8mm, 7mm).....	FTACNP3807.....	19
Conical NP (3.8mm, 9mm).....	FTACNP3809.....	19
Conical NP (3.8mm, 11mm).....	FTACNP3811.....	19
Conical RP (3.8mm, 5mm).....	FTACRP3805.....	19
Conical RP (3.8mm, 7mm).....	FTACRP3807.....	19
Conical RP (3.8mm, 9mm).....	FTACRP3809.....	19
Conical RP (3.8mm, 11mm).....	FTACRP3811.....	19
Hex (3.8mm, 5mm).....	FTAH3805.....	19
Hex (3.8mm, 7mm).....	FTAH3807.....	19
Hex (3.8mm, 9mm).....	FTAH3809.....	19
Hex (3.8mm, 11mm).....	FTAH3811.....	19
Flat Titanium Slim Abutment		19
Slim (3.7mm, 1mm).....	FSACSP3710.....	19
Slim (3.7mm, 2mm).....	FSACSP3720.....	19
Slim (3.7mm, 3mm).....	FSACSP3730.....	19
Flat Titanium Standard Abutment		19
Conical NP (4.5mm, 5mm).....	FTACNP4505.....	19
Conical NP (4.5mm, 7mm).....	FTACNP4507.....	19
Conical NP (4.5mm, 9mm).....	FTACNP4509.....	19
Conical NP (4.5mm, 11mm).....	FTACNP4511.....	19
Conical RP (4.5mm, 5mm).....	FTACRP4505.....	19
Conical RP (4.5mm, 7mm).....	FTACRP4507.....	19
Conical RP (4.5mm, 9mm).....	FTACRP4509.....	19
Conical RP (4.5mm, 11mm).....	FTACRP4511.....	19

Hex (4.5mm, 5mm).....	FTAH4505.....	19
Hex (4.5mm, 7mm).....	FTAH4507.....	19
Hex (4.5mm, 9mm).....	FTAH4509.....	19
Hex (4.5mm, 11mm).....	FTAH4511.....	19
Flat Titanium Wide Abutment.....		19
Conical RP (5.5mm, 5mm).....	FTACRP5505.....	19
Conical RP (5.5mm, 7mm).....	FTACRP5507.....	19
Conical RP (5.5mm, 9mm).....	FTACRP5509.....	19
Conical RP (5.5mm, 11mm).....	FTACRP5511.....	19
Hex (5.5mm, 5mm).....	FTAH5505.....	19
Hex (5.5mm, 7mm).....	FTAH5507.....	19
Hex (5.5mm, 9mm).....	FTAH5509.....	19
Hex (5.5mm, 11mm).....	FTAH5511.....	19
Foley Caliper.....	ESC-FC.....	32
H		
Hand Adapter.....	ADAPTER-H.....	36
Handpiece Adapter.....	ADAPTER-A.....	36
Hand Held Driver.....	SCA635.....	31
Hand Wrench Hex (.25mm).....	TWRCHT.....	31
Healing Cap for Multi-Unit.....	MHCC4550.....	21
I		
Implant Carrier.....		18
Conical NP (5mm).....	ICNP5.....	18
Conical NP (10mm).....	ICNP10.....	18
Conical RP (5mm).....	ICRP5.....	18
Conical RP (10mm).....	ICRP10.....	18
Hex (5mm).....	ICH5.....	18
Hex (10mm).....	ICH10.....	18
Slim Conical (5mm).....	ICCS5.....	18
Slim Conical (10mm).....	ICCS10.....	18
Implant Prosthetic Indicator.....		22
Implant Motor Mounts.....		31
Conical NP Long (2.25mm, 28mm).....	MMCN228.....	31
Conical NP Short (2.25mm, 22mm).....	MMCN222.....	31
Conical RP Long (2.65mm, 28mm).....	MMCRP228.....	31
Conical RP Short (2.65mm, 22mm).....	MMCRP222.....	31
Hex .050/1.25 Long (1.25mm, 28mm).....	MMH128.....	31
Hex .050/1.25 Short (1.25mm, 22mm).....	MMH122.....	31
Hex Long (2.42mm, 28mm).....	MMH228.....	31
Hex Short (2.42mm, 22mm).....	MMH222.....	31
Implant Prosthetic Indicator Conical NP (3.85mm, 1mm).....	LOHNP1.....	22
Implant Prosthetic Indicator Conical NP (3.85mm, 2mm).....	LOHNP2.....	22
Implant Prosthetic Indicator Conical NP (3.85mm, 3mm).....	LOHNP3.....	22
Implant Prosthetic Indicator Conical NP (3.85mm, 4mm).....	LOHNP4.....	22
Implant Prosthetic Indicator Conical NP (3.85mm, 5mm).....	LOHNP5.....	22
Implant Prosthetic Indicator Conical NP (3.85mm, 6mm).....	LOHNP6.....	22
Implant Prosthetic Indicator Conical RP (3.85mm, 1mm).....	LOHRP1.....	22
Implant Prosthetic Indicator Conical RP (3.85mm, 2mm).....	LOHRP2.....	22
Implant Prosthetic Indicator Conical RP (3.85mm, 3mm).....	LOHRP3.....	22
Implant Prosthetic Indicator Conical RP (3.85mm, 4mm).....	LOHRP4.....	22
Implant Prosthetic Indicator Conical RP (3.85mm, 5mm).....	LOHRP5.....	22
Implant Prosthetic Indicator Conical RP (3.85mm, 6mm).....	LOHRP6.....	22
Implant Prosthetic Indicator Hex (3.85mm, 1mm).....	LOH1.....	22
Implant Prosthetic Indicator Hex (3.85mm, 2mm).....	LOH2.....	22
Implant Prosthetic Indicator Hex (3.85mm, 3mm).....	LOH3.....	22
Implant Prosthetic Indicator Hex (3.85mm, 4mm).....	LOH4.....	22
Implant Prosthetic Indicator Hex (3.85mm, 5mm).....	LOH5.....	22
Implant Prosthetic Indicator Hex (3.85mm, 6mm).....	LOH6.....	22
Implant Prosthetic Indicator Cover.....		22
Hard Plastic.....	NIP3.....	22
Metal.....	MAC1.....	22
Soft Plastic.....	NIP2.....	22
Standard Plastic.....	NIP1.....	22
Implant—Torque.....	ITRQ.....	35

Impression Transfers.....		18
Irrigation Syringe.....	ESC-IS.....	32
L		
Lab Analog.....		23
Titanium Lab Analog Conical NP (4mm, 12mm).....	ECACNP.....	23
Titanium Lab Analog Conical RP (4mm, 12mm).....	ECACRP.....	23
Titanium Lab Analog Hex (4mm, 12mm).....	ECAH.....	23
Titanium Lab Analog Slim Conical (3.0mm, 12mm).....	ECACSP30.....	23
Lab—Titanium based Conical & Hex Plastic Sleeve.....		23
Plastic Conical (1mm, 12mm).....	SPC8218.....	40
Plastic & Titanium Conical (1mm, 12mm).....	SPTC3112.....	40
Plastic Hex (1mm, 12mm).....	SP8218.....	40
Plastic & Titanium Hex (1mm, 12mm).....	SPT3112.....	40
Plastic Slim Conical (1mm, 12mm).....	SPCS8218.....	40
Plastic & Titanium Slim Conical (1mm, 12mm).....	SPTCSP3112.....	40
Lateral Drills and Reamers.....		40
Lateral Drill (1mm).....	SMK2-02-4.2.....	40
Lateral Drill 2 (1mm).....	SMK2-03-6.5-1.....	40
Lateral Reamer (2mm).....	SMK2-03-2.....	40
Lateral Reamer (3mm).....	SMK2-03-3.....	40
M		
Mini Black Box for Surgical/Drill Stoppers Kits.....	A8.....	26-27, 30
Mini Surgical Tray—ESI/Premium Implants.....	MSKEP.....	26
Mini Surgical Tray—Ultimate Implants.....	MSKU.....	27
Mini White Tray for Drill Stoppers Kit.....	STGS.....	30
Mini White Tray for Surgical Kits.....	MSTG.....	26-27
Minnesota Retractor.....	ESC-MR.....	32
Motor Mounts.....		31
Motors and Hand-Held Drills.....		45
Multi-Unit Abutments.....		21
O		
Open Tray Impression Transfer.....		18
Conical NP (10mm).....	ITOCNP10.....	18
Conical NP (15mm).....	ITOCNP15.....	18
Conical RP (10mm).....	ITOCRNP10.....	18
Conical RP (15mm).....	ITOCRNP15.....	18
Hex (10mm).....	ITOH10.....	18
Hex (15mm).....	ITOH15.....	18
Slim Conical (10mm).....	ITOCSP10.....	18
Slim Conical (15mm).....	ITOCSP15.....	18
Transfer Screw Conical NP.....	ITSNP.....	18
Transfer Screw Conical RP.....	ITSRP.....	18
Transfer Screw Hex.....	ITSH.....	18
Transfer Screw Slim Conical.....	ITCSP.....	18
Open Tray Transfer.....	MTMU1200.....	21
Oral Surgery Motor.....	XCIE.....	45
Osteotome Sinus Lift.....		34
Osteotome Sinus Lift Curved 1 (2.5mm).....	OSTSL-C1.....	34
Osteotome Sinus Lift Curved 2 (3.0mm).....	OSTSL-C2.....	34
Osteotome Sinus Lift Curved 3 (3.7mm).....	OSTSL-C3.....	34
Osteotome Sinus Lift Curved 4 (4.5mm).....	OSTSL-C4.....	34
Osteotome Sinus Lift Curved 5 (5.0mm).....	OSTSL-C5.....	34
Osteotome Sinus Lift Straight 1 (2.5mm).....	OSTSL-S1.....	34
Osteotome Sinus Lift Straight 2 (3.0mm).....	OSTSL-S2.....	34
Osteotome Sinus Lift Straight 3 (3.7mm).....	OSTSL-S3.....	34
Osteotome Sinus Lift Straight 4 (4.5mm).....	OSTSL-S4.....	34
Osteotome Sinus Lift Straight 5 (5.0mm).....	OSTSL-S5.....	34
P		
PEEK Temporary Abutment.....		20

Abutment with Shoulder Conical NP (4.5mm, 10mm, 1mm).....	PACNP1001.....	20
Abutment with Shoulder Conical NP (4.5mm, 11mm, 2mm).....	PACNP1102.....	20
Abutment with Shoulder Conical NP (4.5mm, 12mm, 3mm).....	PACNP1203.....	20
Abutment with Shoulder Conical RP (4.5mm, 10mm, 1mm).....	PACRP1001.....	20
Abutment with Shoulder Conical RP (4.5mm, 11mm, 2mm).....	PACRP1102.....	20
Abutment with Shoulder Conical RP (4.5mm, 12mm, 3mm).....	PACRP1203.....	20
Abutment with Shoulder Hex (4.5mm, 10mm, 1mm).....	PAH1001.....	20
Abutment with Shoulder Hex (4.5mm, 11mm, 2mm).....	PAH1102.....	20
Abutment with Shoulder Hex (4.5mm, 12mm, 3mm).....	PAH1203.....	20
Abutment with Shoulder Slim Conical (4.5mm, 10mm, 1mm).....	PACSP1001.....	20
Abutment with Shoulder Slim Conical (4.5mm, 11mm, 2mm).....	PACSP1102.....	20
Abutment with Shoulder Slim Conical (4.5mm, 12mm, 3mm).....	PACSP1203.....	20
Anatomic Conical NP (4.5mm, 10mm, 1mm).....	APACNP1001.....	20
Anatomic Conical NP (4.5mm, 11mm, 2mm).....	APACNP1102.....	20
Anatomic Conical NP (4.5mm, 12mm, 3mm).....	APACNP1203.....	20
Anatomic Conical RP (4.5mm, 10mm, 1mm).....	APACRP1001.....	20
Anatomic Conical RP (4.5mm, 11mm, 2mm).....	APACRP1102.....	20
Anatomic Conical RP (4.5mm, 12mm, 3mm).....	APACRP1203.....	20
Anatomic Hex (4.5mm, 10mm, 1mm).....	APAH1001.....	20
Anatomic Hex (4.5mm, 11mm, 2mm).....	APAH1102.....	20
Anatomic Hex (4.5mm, 12mm, 3mm).....	APAH1203.....	20
Anatomic Slim Conical (4.5mm, 10mm, 1mm).....	APACSP1001.....	20
Anatomic Slim Conical (4.5mm, 11mm, 2mm).....	APACSP1102.....	20
Anatomic Slim Conical (4.5mm, 12mm, 3mm).....	APACSP1203.....	20
Penguin Stability Tester.....	PNST.....	45
Periodontal Probe.....	ESC-PP.....	32
Periosteal Elevator.....	ESC-PE.....	32
Periotome Extraction Kit.....	PEREX.....	33
Periotome Extraction - Curved.....	PEREX-CR.....	33
Periotome Extraction - Distal.....	PEREX-DS.....	33
Periotome Extraction - Mesial.....	PEREX-MS.....	33
Periotome Extraction - Spade.....	PEREX-SP.....	33
Periotome Extraction - Straight.....	PEREX-ST.....	33
Periotome Extraction - Wide Mesial.....	PEREX-WM.....	33
Periotome Extraction - Wide Spade.....	PEREX-WS.....	33
Plastic Sleeve.....	MUPS0032.....	21
Plastic Sleeve for Closed tray Transfer.....	MWQP0011.....	21
Premium Implant.....		12
Premium Implant Conical (3.5mm, 8mm).....	PRC35008.....	13
Premium Implant Conical (3.5mm, 10mm).....	PRC35010.....	13
Premium Implant Conical (3.5mm, 11mm).....	PRC35011.....	13
Premium Implant Conical (3.5mm, 13mm).....	PRC35013.....	13
Premium Implant Conical (3.5mm, 15mm).....	PRC35015.....	13
Premium Implant Conical (4.3mm, 6mm).....	PRC43006.....	13
Premium Implant Conical (4.3mm, 8mm).....	PRC43008.....	13
Premium Implant Conical (4.3mm, 10mm).....	PRC43010.....	13
Premium Implant Conical (4.3mm, 11mm).....	PRC43011.....	13
Premium Implant Conical (4.3mm, 13mm).....	PRC43013.....	13
Premium Implant Conical (4.3mm, 15mm).....	PRC43015.....	13
Premium Implant Conical (5.0mm, 6mm).....	PRC50006.....	13
Premium Implant Conical (5.0mm, 8mm).....	PRC50008.....	13
Premium Implant Conical (5.0mm, 10mm).....	PRC50010.....	13
Premium Implant Conical (5.0mm, 11mm).....	PRC50011.....	13
Premium Implant Conical (5.0mm, 13mm).....	PRC50013.....	13
Premium Implant Conical (5.0mm, 15mm).....	PRC50015.....	13
Premium Implant Conical (6.0mm, 6mm).....	PRC60006.....	13
Premium Implant Conical (6.0mm, 8mm).....	PRC60008.....	13
Premium Implant Conical (6.0mm, 10mm).....	PRC60010.....	13
Premium Implant Conical (6.0mm, 11mm).....	PRC60011.....	13
Premium Implant Conical (6.0mm, 13mm).....	PRC60013.....	13
Premium Implant Conical (6.0mm, 15mm).....	PRC60015.....	13
Premium Implant Hex (3.5mm, 8mm).....	PR35008.....	13
Premium Implant Hex (3.5mm, 10mm).....	PR35010.....	13
Premium Implant Hex (3.5mm, 11mm).....	PR35011.....	13
Premium Implant Hex (3.5mm, 13mm).....	PR35013.....	13
Premium Implant Hex (3.5mm, 15mm).....	PR35015.....	13
Premium Implant Hex (4.3mm, 6mm).....	PR43006.....	13

INDEX

Premium Implant Hex (4.3mm, 8mm).....	PR43008	13
Premium Implant Hex (4.3mm, 10mm).....	PR43010	13
Premium Implant Hex (4.3mm, 11mm).....	PR43011	13
Premium Implant Hex (4.3mm, 13mm).....	PR43013	13
Premium Implant Hex (4.3mm, 15mm).....	PR43015	13
Premium Implant Hex (5.0mm, 6mm).....	PR50006	13
Premium Implant Hex (5.0mm, 8mm).....	PR50008	13
Premium Implant Hex (5.0mm, 10mm).....	PR50010	13
Premium Implant Hex (5.0mm, 11mm).....	PR50011	13
Premium Implant Hex (5.0mm, 13mm).....	PR50013	13
Premium Implant Hex (5.0mm, 15mm).....	PR50015	13
Premium Implant Hex (6.0mm, 6mm).....	PR60006	13
Premium Implant Hex (6.0mm, 8mm).....	PR60008	13
Premium Implant Hex (6.0mm, 10mm).....	PR60010	13
Premium Implant Hex (6.0mm, 11mm).....	PR60011	13
Premium Implant Hex (6.0mm, 13mm).....	PR60013	13
Premium Implant Hex (6.0mm, 15mm).....	PR60015	13
R		
Ratchet.....	WR	31
Ratchet Abutment Screw Driver Hex Long (1.25mm, 15mm).....	HXD115	31
Ratchet Abutment Screw Driver Hex Short (1.25mm, 7mm).....	HXD107	31
Ratchet Implant Drivers		
Conical NP (2.25mm, 13mm).....	CNDP213	31
Conical RP (2.65mm, 13mm).....	CDRP213	31
Hex (2.42mm, 13mm).....	HXD213	31
Ratchet Mounts.....		31
S		
Saw.....		37
Saw (7mm).....	SAW-01	37
Saw (10mm).....	SAW-01	37
Scalpel Handle.....	ESC-SH	32
Screw Driver (1.25mm).....	HND10	31
Screw Driver (10/15mm).....	HND15	31
Screw for Multi-Unit Sleeve.....	MSMU4023	21
Screw Removal Kit		
Screw Removal Drill.....	SRD-01	39
Screw Removal Guide 1.....	SRG-EM	39
Screw Removal Guide 2.....	SRG-IO	39
Screw Removal Guide 3.....	SRG-TSV3.7/4.1	39
Screw Removal Guide 4.....	SRG-ER	39
Screw Removal Guide 5.....	SRG-SH	39
Screw Removal Guide 6.....	SRG-TSV4.7	39
Screw Removal Tap.....	SRT-01	39
Screws		
Sinus Lift.....		41
Sinus Lift 1.....	SLC-02	41
Sinus Lift 2.....	YSL-02	41
Sinus Lift 3.....	YSL-03	41
Sinus Lift Crestal 2.....	SLC-02	41
Sinus Master Kit		
Stoppers.....	SMK3-01	40
Stopper (1mm).....	MAS-02-01	41
Stopper (2mm).....	MAS-02-02	41
Stopper (3mm).....	MAS-02-03	41
Stopper (4mm).....	MAS-02-04	41
Stopper (5mm).....	MAS-02-05	41
Stopper (6mm).....	MAS-02-06	41
Stopper (7mm).....	MAS-02-07	41
Stopper (8mm).....	MAS-02-08	41
Solo One Piece Implant.....		16
Solo One Piece Implant (3.0mm, 10mm).....	OP3010	16
Solo One Piece Implant (3.0mm, 11mm).....	OP3011	16
Solo One Piece Implant (3.0mm, 13mm).....	OP3013	16
Solo One Piece Implant (3.0mm, 15mm).....	OP3015	16

Solo One Piece Implant (3.3mm, 10mm).....	OP3310	16
Solo One Piece Implant (3.3mm, 11mm).....	OP3311	16
Solo One Piece Implant (3.3mm, 13mm).....	OP3313	16
Solo One Piece Implant (3.3mm, 15mm).....	OP3315	16
Solo One Piece Implant (3.75mm, 10mm).....	OP37510	16
Solo One Piece Implant (3.75mm, 11mm).....	OP37511	16
Solo One Piece Implant (3.75mm, 13mm).....	OP37513	16
Solo One Piece Implant (3.75mm, 15mm).....	OP37515	16
Solo One Piece Implant (4.2mm, 10mm).....	OP4210	16
Solo One Piece Implant (4.2mm, 11mm).....	OP4211	16
Solo One Piece Implant (4.2mm, 13mm).....	OP4213	16
Solo One Piece Implant (4.2mm, 15mm).....	OP4215	16
SpiralTech Implant Motor.....	IMM60	45
Split Chisel		
Split Chisel Curved (4mm).....	SPC-03	37
Split Chisel Curved (6mm).....	SPC-05	37
Split Chisel Straight (4mm).....	SPC-02	37
Split Chisel Straight (6mm).....	SPC-04	37
Split Master Kit.....	SSM-02	37
Spreader Holder.....	SS-BAR	37
Spreader Screw.....	BCT-01-01	37
Straight Abutment Screw Conical NP (9.4mm).....	SCACNP94	23
Straight Abutment Screw Conical RP (9.4mm).....	SCACRP94	23
Straight Abutment Screw Hex (9.4mm).....	SCA94	23
Straight Abutment Screw Slim Conical (9.4mm).....	SCACSP94	23
Straight Multi-Unit Abutment Conical NP (1mm).....	00MUANP1	21
Straight Multi-Unit Abutment Conical NP (2mm).....	00MUANP2	21
Straight Multi-Unit Abutment Conical NP (3mm).....	00MUANP3	21
Straight Multi-Unit Abutment Conical NP (4mm).....	00MUANP4	21
Straight Multi-Unit Abutment Conical RP (1mm).....	00MUARP1	21
Straight Multi-Unit Abutment Conical RP (2mm).....	00MUARP2	21
Straight Multi-Unit Abutment Conical RP (3mm).....	00MUARP3	21
Straight Multi-Unit Abutment Conical RP (4mm).....	00MUARP4	21
Straight Multi-Unit Abutment Hex (1mm).....	00MUAH1	21
Straight Multi-Unit Abutment Hex (2mm).....	00MUAH2	21
Straight Multi-Unit Abutment Hex (3mm).....	00MUAH3	21
Straight Multi-Unit Abutment Hex (4mm).....	00MUAH4	21
Straight Multi-Unit System.....	MUS	21
Straight Osteotome Sinus Lift.....	OSTSL-S	34
Suction Tip.....	ESC-ST	32
Surgical Tools		
Surgical Kits.....		24-27
Surgical Kit for ESi/Premium Implants.....	SKEP	24
Surgical Kit for Ultimate Implants.....	SKU	25
T		
Tissue Punch (3.0mm x 4.0mm).....	TPU30/40	31
Tissue Punch (4.0mm x 5.0mm).....	TPU40/50	31
Titanium Based Plastic Sleeve Hex (1mm, 12mm).....	SP8218	23
Titanium Healing Abutment		
Anatomic Healing Cap Abutment Conical NP (4.5mm, 3mm).....	AHACNP453	17
Anatomic Healing Cap Abutment Conical NP (4.5mm, 4mm).....	AHACNP454	17
Anatomic Healing Cap Abutment Conical NP (4.5mm, 5mm).....	AHACNP455	17
Anatomic Healing Cap Abutment Conical NP (4.5mm, 6mm).....	AHACNP456	17
Anatomic Healing Cap Abutment Conical NP (5.5mm, 3mm).....	AHACNP553	17
Anatomic Healing Cap Abutment Conical NP (5.5mm, 4mm).....	AHACNP554	17
Anatomic Healing Cap Abutment Conical NP (5.5mm, 5mm).....	AHACNP555	17
Anatomic Healing Cap Abutment Conical NP (5.5mm, 6mm).....	AHACNP556	17
Anatomic Healing Cap Abutment Conical RP (4.5mm, 3mm).....	AHACRP453	17
Anatomic Healing Cap Abutment Conical RP (4.5mm, 4mm).....	AHACRP454	17
Anatomic Healing Cap Abutment Conical RP (4.5mm, 5mm).....	AHACRP455	17
Anatomic Healing Cap Abutment Conical RP (4.5mm, 6mm).....	AHACRP456	17
Anatomic Healing Cap Abutment Conical RP (5.5mm, 3mm).....	AHACRP553	17
Anatomic Healing Cap Abutment Conical RP (5.5mm, 4mm).....	AHACRP554	17
Anatomic Healing Cap Abutment Conical RP (5.5mm, 5mm).....	AHACRP555	17
Anatomic Healing Cap Abutment Conical RP (5.5mm, 6mm).....	AHACRP556	17

Anatomic Healing Cap Abutment Conical RP (6.5mm, 3mm).....	AHACRP653	17
Anatomic Healing Cap Abutment Conical RP (6.5mm, 4mm).....	AHACRP654	17
Anatomic Healing Cap Abutment Conical RP (6.5mm, 5mm).....	AHACRP655	17
Anatomic Healing Cap Abutment Conical RP (6.5mm, 6mm).....	AHACRP656	17
Anatomic Healing Cap Abutment Hex (4.5mm, 3mm).....	AHAH453	17
Anatomic Healing Cap Abutment Hex (4.5mm, 4mm).....	AHAH454	17
Anatomic Healing Cap Abutment Hex (4.5mm, 5mm).....	AHAH455	17
Anatomic Healing Cap Abutment Hex (4.5mm, 6mm).....	AHAH456	17
Anatomic Healing Cap Abutment Hex (5.5mm, 3mm).....	AHAH553	17
Anatomic Healing Cap Abutment Hex (5.5mm, 4mm).....	AHAH554	17
Anatomic Healing Cap Abutment Hex (5.5mm, 5mm).....	AHAH555	17
Anatomic Healing Cap Abutment Hex (5.5mm, 6mm).....	AHAH556	17
Anatomic Healing Cap Abutment Hex (6.5mm, 3mm).....	AHAH653	17
Anatomic Healing Cap Abutment Hex (6.5mm, 4mm).....	AHAH654	17
Anatomic Healing Cap Abutment Hex (6.5mm, 5mm).....	AHAH655	17
Anatomic Healing Cap Abutment Hex (6.5mm, 6mm).....	AHAH656	17
Healing Cap Abutment Conical NP Medium (4.5mm, 2mm).....	HACNP452	17
Healing Cap Abutment Conical NP Medium (4.5mm, 3mm).....	HACNP453	17
Healing Cap Abutment Conical NP Medium (4.5mm, 4mm).....	HACNP454	17
Healing Cap Abutment Conical NP Medium (4.5mm, 5mm).....	HACNP455	17
Healing Cap Abutment Conical NP Medium (4.5mm, 6mm).....	HACNP456	17
Healing Cap Abutment Conical NP Narrow (3.8mm, 2mm).....	HACNP382	17
Healing Cap Abutment Conical NP Narrow (3.8mm, 3mm).....	HACNP383	17
Healing Cap Abutment Conical NP Narrow (3.8mm, 4mm).....	HACNP384	17
Healing Cap Abutment Conical NP Narrow (3.8mm, 5mm).....	HACNP385	17
Healing Cap Abutment Conical NP Narrow (3.8mm, 6mm).....	HACNP386	17
Healing Cap Abutment Conical RP Medium (4.5mm, 2mm).....	HACRP452	17
Healing Cap Abutment Conical RP Medium (4.5mm, 3mm).....	HACRP453	17
Healing Cap Abutment Conical RP Medium (4.5mm, 4mm).....	HACRP454	17
Healing Cap Abutment Conical RP Medium (4.5mm, 5mm).....	HACRP455	17
Healing Cap Abutment Conical RP Medium (4.5mm, 6mm).....	HACRP456	17
Healing Cap Abutment Conical RP Narrow (3.8mm, 2mm).....	HACRP382	17
Healing Cap Abutment Conical RP Narrow (3.8mm, 3mm).....	HACRP383	17
Healing Cap Abutment Conical RP Narrow (3.8mm, 4mm).....	HACRP384	17
Healing Cap Abutment Conical RP Narrow (3.8mm, 5mm).....	HACRP385	17
Healing Cap Abutment Conical RP Narrow (3.8mm, 6mm).....	HACRP386	17
Healing Cap Abutment Conical RP Wide (5.5mm, 2mm).....	HACRP502	17
Healing Cap Abutment Conical RP Wide (5.5mm, 3mm).....	HACRP503	17
Healing Cap Abutment Conical RP Wide (5.5mm, 4mm).....	HACRP504	17
Healing Cap Abutment Conical RP Wide (5.5mm, 5mm).....	HACRP505	17
Healing Cap Abutment Conical RP Wide (5.5mm, 6mm).....	HACRP506	17
Healing Cap Abutment Conical RP Wide (6.0mm, 2mm).....	HACRP602	17
Healing Cap Abutment Conical RP Wide (6.0mm, 3mm).....	HACRP603	17
Healing Cap Abutment Conical RP Wide (6.0mm, 4mm).....	HACRP604	17
Healing Cap Abutment Conical RP Wide (6.0mm, 5mm).....	HACRP605	17
Healing Cap Abutment Conical RP Wide (6.0mm, 6mm).....	HACRP606	17
Healing Cap Abutment Hex Medium (4.5mm, 2mm).....	AHAH452	17
Healing Cap Abutment Hex Medium (4.5mm, 3mm).....	AHAH453	17
Healing Cap Abutment Hex Medium (4.5mm, 4mm).....	AHAH454	17
Healing Cap Abutment Hex Medium (4.5mm, 5mm).....	AHAH455	17
Healing Cap Abutment Hex Medium (4.5mm, 6mm).....	AHAH456	17
Healing Cap Abutment Hex Narrow (3.8mm, 2mm).....	AHAH382	17
Healing Cap Abutment Hex Narrow (3.8mm, 3mm).....	AHAH383	17
Healing Cap Abutment Hex Narrow (3.8mm, 4mm).....	AHAH384	17
Healing Cap Abutment Hex Narrow (3.8mm, 5mm).....	AHAH385	17
Healing Cap Abutment Hex Narrow (3.8mm, 6mm).....	AHAH386	17
Healing Cap Abutment Hex Wide (5.5mm, 2mm).....	AHAH552	17
Healing Cap Abutment Hex Wide (5.5mm, 3mm).....	AHAH553	17
Healing Cap Abutment Hex Wide (5.5mm, 4mm).....	AHAH554	17
Healing Cap Abutment Hex Wide (5.5mm, 5mm).....	AHAH555	17
Healing Cap Abutment Hex Wide (5.5mm, 6mm).....	AHAH556	17
Healing Cap Abutment Hex Wide (6.0mm, 2mm).....	AHAH602	17
Healing Cap Abutment Hex Wide (6.0mm, 3mm).....	AHAH603	17
Healing Cap Abutment Hex Wide (6.0mm, 4mm).....	AHAH604	17
Healing Cap Abutment Hex Wide (6.0mm, 5mm).....	AHAH605	17
Healing Cap Abutment Hex Wide (6.0mm, 6mm).....	AHAH606	17
Healing Cap Abutment Slim Conical (3.5mm, 2mm).....	HACSP352	17

Healing Cap Abutment Slim Conical (3.5mm, 3mm)	HACSP353	17
Healing Cap Abutment Slim Conical (3.5mm, 4mm)	HACSP354	17
Healing Cap Abutment Slim Conical (3.5mm, 5mm)	HACSP355	17
Healing Cap Abutment Slim Conical (3.5mm, 6mm)	HACSP356	17
Titanium Sleeve	MUTS1250	21
Torque Ratchet	TWR	31

U

Ultimate Implant		14
Ultimate Implant Conical (3.0mm, 10mm)	ULC30010	15
Ultimate Implant Conical (3.0mm, 11mm)	ULC30011	15
Ultimate Implant Conical (3.0mm, 13mm)	ULC30013	15
Ultimate Implant Conical (3.0mm, 15mm)	ULC30015	15
Ultimate Implant Conical (3.5mm, 8mm)	ULC35008	15
Ultimate Implant Conical (3.5mm, 10mm)	ULC35010	15
Ultimate Implant Conical (3.5mm, 11mm)	ULC35011	15
Ultimate Implant Conical (3.5mm, 13mm)	ULC35013	15
Ultimate Implant Conical (3.5mm, 15mm)	ULC35015	15
Ultimate Implant Conical (4.3mm, 6mm)	ULC43006	15
Ultimate Implant Conical (4.3mm, 8mm)	ULC43008	15
Ultimate Implant Conical (4.3mm, 10mm)	ULC43010	15
Ultimate Implant Conical (4.3mm, 11mm)	ULC43011	15
Ultimate Implant Conical (4.3mm, 13mm)	ULC43013	15
Ultimate Implant Conical (4.3mm, 15mm)	ULC43015	15
Ultimate Implant Conical (5.0mm, 6mm)	ULC50006	15
Ultimate Implant Conical (5.0mm, 8mm)	ULC50008	15
Ultimate Implant Conical (5.0mm, 10mm)	ULC50010	15
Ultimate Implant Conical (5.0mm, 11mm)	ULC50011	15
Ultimate Implant Conical (5.0mm, 13mm)	ULC50013	15
Ultimate Implant Conical (5.0mm, 15mm)	ULC50015	15
Ultimate Implant Conical (6.0mm, 6mm)	ULC60006	15
Ultimate Implant Conical (6.0mm, 8mm)	ULC60008	15
Ultimate Implant Conical (6.0mm, 10mm)	ULC60010	15
Ultimate Implant Conical (6.0mm, 11mm)	ULC60011	15
Ultimate Implant Conical (6.0mm, 13mm)	ULC60013	15
Ultimate Implant Conical (6.0mm, 15mm)	ULC60015	15
Ultimate Implant Hex (3.5mm, 8mm)	UL35008	15
Ultimate Implant Hex (3.5mm, 10mm)	UL35010	15
Ultimate Implant Hex (3.5mm, 11mm)	UL35011	15
Ultimate Implant Hex (3.5mm, 13mm)	UL35013	15
Ultimate Implant Hex (3.5mm, 15mm)	UL35015	15
Ultimate Implant Hex (4.3mm, 6mm)	UL43006	15
Ultimate Implant Hex (4.3mm, 8mm)	UL43008	15
Ultimate Implant Hex (4.3mm, 10mm)	UL43010	15
Ultimate Implant Hex (4.3mm, 11mm)	UL43011	15
Ultimate Implant Hex (4.3mm, 13mm)	UL43013	15
Ultimate Implant Hex (4.3mm, 15mm)	UL43015	15
Ultimate Implant Hex (5.0mm, 6mm)	UL50006	15
Ultimate Implant Hex (5.0mm, 8mm)	UL50008	15
Ultimate Implant Hex (5.0mm, 10mm)	UL50010	15
Ultimate Implant Hex (5.0mm, 11mm)	UL50011	15
Ultimate Implant Hex (5.0mm, 13mm)	UL50013	15
Ultimate Implant Hex (5.0mm, 15mm)	UL50015	15
Ultimate Implant Hex (6.0mm, 6mm)	UL60006	15
Ultimate Implant Hex (6.0mm, 8mm)	UL60008	15
Ultimate Implant Hex (6.0mm, 10mm)	UL60010	15
Ultimate Implant Hex (6.0mm, 11mm)	UL60011	15
Ultimate Implant Hex (6.0mm, 13mm)	UL60013	15
Ultimate Implant Hex (6.0mm, 15mm)	UL60015	15
Ultimate Surgical Drills		29
Ultimate Surgical Drill 1	DUAL1	29
Ultimate Surgical Drill 2	DUAL2	29
Ultimate Surgical Drill 3	DUAL3	29
Ultimate Surgical Drill 4	DUAL4	29
Ultimate Surgical Drill 5	DUAL5	29
Ultimate Surgical Drill 6	DUAL6	29

Ultimate Surgical Drill 7	DUAL7	29
Ultimate Surgical Drill 8	DUAL8	29

W

Wrench	RCW-01	36
Wrench Adapter	ADAPTER-1	36
White Tray for ESI/Premium Surgical Kit	STG2	24
White Tray for Ultimate Surgical Kit	STG3	25

Z

Zirconia Healing Abutment		17
Healing Cap Abutment Conical NP (3.8mm, 2mm)	ZHCNP382	17
Healing Cap Abutment Conical NP (3.8mm, 3mm)	ZHCNP383	17
Healing Cap Abutment Conical NP (3.8mm, 4mm)	ZHCNP384	17
Healing Cap Abutment Conical NP (3.8mm, 6mm)	ZHCNP386	17
Healing Cap Abutment Conical NP (5.0mm, 3mm)	ZHCNP433	17
Healing Cap Abutment Conical NP (5.0mm, 4mm)	ZHCNP434	17
Healing Cap Abutment Conical RP (3.8mm, 2mm)	ZHCRP382	17
Healing Cap Abutment Conical RP (3.8mm, 3mm)	ZHCRP383	17
Healing Cap Abutment Conical RP (3.8mm, 4mm)	ZHCRP384	17
Healing Cap Abutment Conical RP (3.8mm, 6mm)	ZHCRP386	17
Healing Cap Abutment Conical RP (5.0mm, 3mm)	ZHCRP433	17
Healing Cap Abutment Conical RP (5.0mm, 4mm)	ZHCRP434	17
Healing Cap Abutment Conical RP (5.5mm, 3mm)	ZHCRP553	17
Healing Cap Abutment Conical RP (5.5mm, 4mm)	ZHCRP554	17
Healing Cap Abutment Hex (3.8mm, 2mm)	ZHCH382	17
Healing Cap Abutment Hex (3.8mm, 3mm)	ZHCH383	17
Healing Cap Abutment Hex (3.8mm, 4mm)	ZHCH384	17
Healing Cap Abutment Hex (3.8mm, 6mm)	ZHCH386	17
Healing Cap Abutment Hex (5.0mm, 3mm)	ZHCH433	17
Healing Cap Abutment Hex (5.0mm, 4mm)	ZHCH434	17
Healing Cap Abutment Hex (5.5mm, 3mm)	ZHCH553	17
Healing Cap Abutment Hex (5.5mm, 4mm)	ZHCH554	17
Healing Cap Abutment Slim Conical (3.5mm, 2mm)	ZHCSP382	17
Healing Cap Abutment Slim Conical (3.5mm, 3mm)	ZHCSP383	17
Healing Cap Abutment Slim Conical (3.5mm, 4mm)	ZHCSP384	17
Healing Cap Abutment Slim Conical (3.5mm, 5mm)	ZHCSP385	17
Healing Cap Abutment Slim Conical (3.5mm, 6mm)	ZHCSP386	17



ProductCatalog-V37-2.28.2020



875 N. Michigan Avenue, Suite 3106
Chicago, IL 60611 United States

Tel: (312) 440-7777

Email: info@spiraltech.com

www.spiraltech.com

Sales & Service

USA: (888) 991-7997

Local: (312) 440-7777

Order Online 24/7: www.SpiralTech.com

©2016 SpiralTech Superior Dental Implants, Inc.

ISO 13485:2016

EC Certificate US15/842415